

WOOD BURNING STOVES



ALL
MODELS
EPA
CERTIFIED



NORTH AMERICA'S FAVORITE FIRE



1979 - First Lopi Wood Stove

Lopi wood stoves have been North America's favorite choice in fire for over 40 years. Our reputation for solid craftsmanship, reliable performance, low emissions and unbeatable heating efficiency has been a winning combination year after year, and the favorite fire of families across the nation.

Lopi heating appliances are designed and hand-assembled at our state-of-the-art factory in Mukilteo, Washington. Each stove comes with our seven year warranty. After all, we have the experience and confidence to stand behind every single product we make, so we put it in writing.

We've learned and grown with every unit we've built over the years, but some things that haven't changed are the beauty of our stoves, performance you can trust, and our commitment to your satisfaction.

Whether you are new to the family of Lopi heating appliances or already a part of our family, we invite you take a look at our line of wood stoves. We know you'll find your favorite fire.



Lopi is not so much a brand name as it is a tradition of craftsmanship in the construction of our wood stoves and of pride to the families who own them. We invite you to share this proud tradition.

KURT W. F. RUMENS
President, Travis Industries

WOOD IS GOOD!

Energy Independence

The expense of heating your home with oil, gas or electricity keeps going up. Lopi's wood stoves deliver both radiant and convective heat that comfortably warms every room in your home for a fraction of what you'd pay for standard utilities.

No Power? No Problem!

A Lopi wood stove will keep you warm and cozy under any circumstance. These stoves do not require blowers to operate, and feature natural convection heat that will warm your home without the use of power, making them a reliable heat source during power outages.

Lopi offers two types of advanced combustion technology that deliver clean burning and efficient EPA certified wood heating solutions.

NexGen-Fyre™ Technology

NexGen-Fyre™ takes our non-catalytic wood burning technology to the next level! With NexGen-Fyre™, primary and secondary combustion are harnessed to create the ultimate blended combustion system. This produces beautiful, balanced fires with double the BTU range, up to 50% greater heat output, and longer burn times than any other non-catalytic technology.

Lopi® Models

Answer NexGen-Fyre™ Stove
Evergreen NexGen-Fyre™ Stove
Endeavor NexGen-Fyre™ Stove
Liberty NexGen-Fyre™ Stove

Hybrid-Fyre® Technology

Hybrid-Fyre® is the most efficient wood burning technology in the world! This patented, award-winning technology highlights the strengths of both catalytic and NexGen-Fyre™ (non-catalytic) technologies to create an advanced combustion system that burns less wood to generate the greatest heat output.

Lopi® Models

Rockport Hybrid-Fyre® Stove



DARE TO COMPARE!

We build the finest wood burning stoves on the planet.

No other wood burning stove can surpass Lopi's performance or quality. It takes the best engineers and craftsmen to make the best products, and we've got them!

Your new Lopi stove features true unibody construction.

Using a 600-ton press to form and bend the metal, we eliminate unsightly welds and increase strength. Your stove also has a 6" heavy-duty, seamless steel flue collar and heavy gauge 5/16" & 3/16" steel construction. When you buy a Lopi, you're buying the finest. We guarantee it.

Tested to EPA's Cord Wood Standard.

Cord wood testing mirrors home use by burning split cord wood pieces and measuring the emissions through the entire range of a unit's operation. Most manufacturers test to the old crib wood standard, which produces great lab results, however does not give you real world measurements on how the unit will operate in your home. Testing to cord wood produces true real world measurements that can be duplicated in your home.



Cast iron door features a raised, pinched door seal and secure locking door handle that ensures an air-tight seal around the glass, so the door will never warp or flex. The frame also protects the glass gasket from direct contact with the fire.



Our single air control is easier to fine tune to your heating needs by regulating both primary and secondary air to the stove. The result is easy operation with optimum efficiency and control throughout the burn cycle.



Lopi uses real kiln-fired, refractory firebrick in the firebox. This is the same material used to line commercial boilers and furnaces, and is twice the weight of typical brick. The brick protects the steel while increasing the internal temperature within the firebox.



A large capacity ash pan allows for quick and easy ash removal simply by sweeping ash from inside the stove down into the pan.

Not available on the Answer NextGen-Fyre™ stove.



Endeavor NexGen-Fyre™ Stove



The Answer NexGen-Fyre™ Stove



NEXGEN-FYRE™ STOVES- PAGES 9-15



ANSWER
NEXGEN-FYRE™



EVERGREEN
NEXGEN-FYRE™
WITH LEG OPTION



EVERGREEN
NEXGEN-FYRE™
WITH PEDESTAL OPTION



ENDEAVOR
NEXGEN-FYRE™



LIBERTY
NEXGEN-FYRE™





ANSWER NEXGEN-FYRE™

Small Stove with Heavy-Duty Construction

The Answer NexGen-Fyre™ is a beautiful small stove built with heavy-duty, high quality construction. This stove uses a five-sided convection chamber to distribute heat evenly throughout your home. Cool room air is naturally drawn around the hot firebox, heated, and returned back into room without using a convection fan. The Answer's™ 1.5 cubic foot firebox is large enough to hold an 18" log, offering longer burn times with less reloading. Alcove and Mobile Home approved.

Options

- 160 CFM Convection Fan
- Outside Air Kit
- **GREEN START™** Igniter (See page 20)

Specifications

Emissions:	2.0 Grams Per Hour
Heating Capacity:*	Up to 1,400 Square Feet
EPA Tested BTU Range:	12,129 to 59,527 BTUs Per Hour
Real World BTUs:	<i>EPA tests to determine BTU output are achieved with a single load of wood at each burn rate. At home, you are likely to add more wood to your insert to maintain your desired comfort level. By the simple process of loading your fireplace insert with additional wood, you could achieve up to a 20% higher heat output than established during EPA testing.</i>
Maximum Burn Time:	Up to 8 Hours
Efficiency:**	72.4% HHV
Glass Viewing Area:	135 sq. in (15-1/4" W x 9-1/4" H)
Firebox Size:	1.5 Cubic Feet
Maximum Log Size:	18"
Weight:	300 Pounds
Construction:	5/16" to 3/16" Steel Plate

* Heating capacity may vary depending on degree of home insulation, floor plan and ambient temperature zone of the area you live.

**As tested using B-415.1 using Cord Wood. HHV = High Heat Value

NEXGEN-FYRE™ WOOD STOVES

Clearances & Hearth Protection

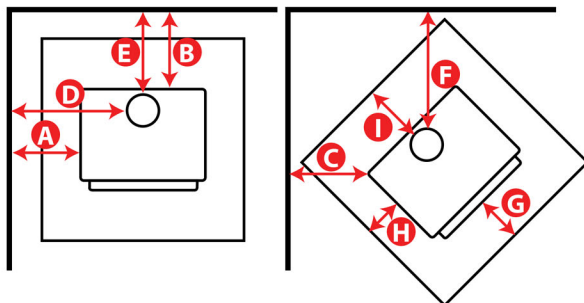

	Single Wall Connector	Double Wall Connector
A	18"	13"
B	16-1/2"	9"
C	10"	7-1/2"
D	27"	21-1/2"
E	19-1/2"	11-1/2"
F	19-1/2"	16-1/2"
	USA	CANADA
G	16"	18"
H	6"	8"
I	6"	8"





EVERGREEN NEXGEN-FYRE™ Premium Steel Wood Stove

The mid-sized Evergreen NexGen-Fyre™ hits the mark on performance, function and design. This sleek stove features gentle curved lines and complements any home's décor while artfully presenting heavy gauge steel, unibody construction and a cast iron door with a large, self-cleaning ceramic glass viewing area. The Evergreen's standard bypass damper gives you full control over the flow of smoke inside this stove, eliminating smoky startups and reloads. Alcove and Mobile Home approved.



Pedestal Model

Options

- Outside Air Kit
- 400 CFM Convection Fan
- **GREEN START™** Igniter (See page 20)

Specifications

Emissions:	1.5 Grams Per Hour
Heating Capacity:*	Up to 2,000 Square Feet
EPA Tested BTU Range:	12,772 to 70,720 BTUs Per Hour
Real World BTUs:	<i>EPA tests to determine BTU output are achieved with a single load of wood at each burn rate. At home, you are likely to add more wood to your insert to maintain your desired comfort level. By the simple process of loading your fireplace insert with additional wood, you could achieve up to a 20% higher heat output than established during EPA testing.</i>
Construction:	5/16" to 3/16" Steel Plate
Efficiency:**	77.1% HHV
Glass Area:	183 sq. in (16-7/8" W x 10-7/8" T)
Maximum Burn Time:	Up to 10 Hours
Firebox Size:	2.2 Cubic Feet
Maximum Log Size:	20-1/2"
Bypass Damper:	Yes
Weight:	455 Pounds

* Heating capacity may vary depending on degree of home insulation, floor plan and ambient temperature zone of the area you live.

**As tested using B-415.1 using Cord Wood. HHV = High Heat Value

Clearances & Hearth Protection

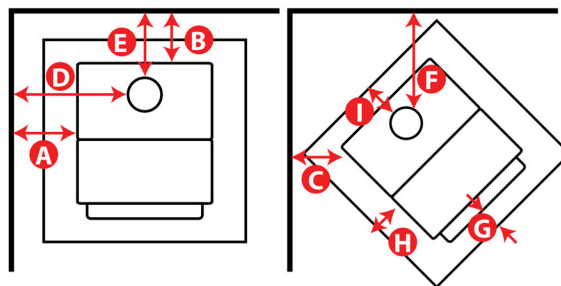

	Single Wall Connector	Double Wall Connector
A	19"	10-1/2"
B	17"	9"
C	8"	4"
D	22-1/2"	21"
E	19"	10-1/2"
F	17-1/2"	13-1/2"
	USA	Canada
G	16"	18"
H	6"	8"
I	6"	8"





ENDEAVOR NEXGEN-FYRE™

Our Best-Selling Wood Stove Since 1984

The Endeavor NexGen-Fyre™ is a true 'best in class' stove because it combines form and function with an unbeatable heat transfer system. This stove is ideal for heating medium to large homes and is one of the cleanest burning mid-sized wood stoves available. The Endeavor NexGen-Fyre™ features a 2.5 cubic foot firebox, along with an elegant door and large 165 square inch viewing area. In addition, the standard ash pan allows for simple clean up, while the bypass damper makes startups easy and prevents smoke-backs during reloading. Alcove and Mobile Home approved.

Options

- 400 CFM Convection Fan
- Outside Air Kit
- **GREEN START™** Igniter (See page 20)

Specifications

Emissions:	1.4 Grams Per Hour
Heating Capacity:*	Up to 2,000 Square Feet
EPA Tested BTU Range:	12,114 to 67,090 BTUs Per Hour
Real World BTUs:	<i>EPA tests to determine BTU output are achieved with a single load of wood at each burn rate. At home, you are likely to add more wood to your insert to maintain your desired comfort level. By the simple process of loading your fireplace insert with additional wood, you could achieve up to a 20% higher heat output than established during EPA testing.</i>
Construction:	5/16" to 3/16" Steel Plate
Efficiency:**	74.2% HHV
Glass Area:	165 sq. in (15-1/4" W x 11-1/4" T)
Maximum Burn Time:	Up to 10 Hours
Firebox Size:	2.5 Cubic Feet
Maximum Log Size:	18"
Bypass Damper:	Yes
Weight:	448 Pounds

* Heating capacity may vary depending on degree of home insulation, floor plan and ambient temperature zone of the area you live.

**As tested using B-415.1 using Cord Wood. HHV = High Heat Value

NEXGEN-FYRE™ WOOD STOVES

Clearances & Hearth Protection

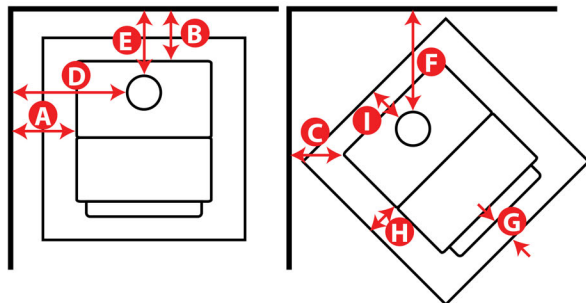

	Single Wall Connector	Double Wall Connector
A	15"	13"
B	17"	9"
C	15"	6-1/2"
D	24"	21-1/2"
E	19-3/4"	11-1/4"
F	24"	15"
	USA	Canada
G	16"	18"
H	6"	8"
I	6"	8"





LIBERTY NEXGEN-FYRE™

A Big Stove That's Big on Heat

The Liberty™ is a large stove made for heating large homes and living spaces. At only 2.5 grams of emissions per hour, it is one of the cleanest burning large stoves approved by the EPA. The huge firebox and fire viewing area allow you to load wood up to 24" long and fully appreciate the splendor of the fire. It also features a single control to adjust air flow, making it easy to achieve burn times up to 12 hours. This stove uses a 6" diameter flue, compared to the more expensive 8" flue required by other large wood stoves. The Liberty's step-top design is enchanting yet functional, providing cooking and warming surfaces as well as radiant and convective heat. Alcove and Mobile Home approved.

Options

- 400 CFM Convection Fan
- Outside Air Kit
- **GREEN START™** Igniter (See page 20)

Specifications

Emissions:	2.5 Grams Per Hour
Heating Capacity:*	Up to 2,000 Square Feet
EPA Tested BTU Range:	15,155 to 63,239 BTUs Per Hour
Real World BTUs:	<i>EPA tests to determine BTU output are achieved with a single load of wood at each burn rate. At home, you are likely to add more wood to your insert to maintain your desired comfort level. By the simple process of loading your fireplace insert with additional wood, you could achieve up to a 20% higher heat output than established during EPA testing.</i>
Construction:	5/16" to 3/16" Steel Plate
Efficiency:**	70% HHV
Glass Area:	232 sq. in (21-1/4"W x 11-3/4"T)
Maximum Burn Time:	Up to 12 Hours
Firebox Size:	3.65 Cubic Feet
Maximum Log Size:	24"
Bypass Damper:	Yes
Weight:	570 Pounds

* Heating capacity may vary depending on degree of home insulation, floor plan and ambient temperature zone of the area you live.

**As tested using B-415.1 using Cord Wood. HHV = High Heat Value

Clearances & Hearth Protection

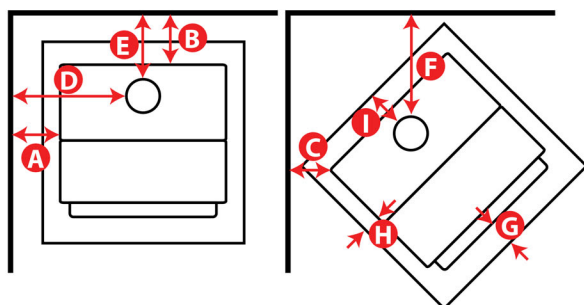

	Single Wall Connector	Double Wall Connector
A	16"	16"
B	15"	10"
C	9-1/2"	7-1/2"
D	28"	27-1/2"
E	18-1/4"	12-3/4"
F	21"	18-1/2"
	USA	Canada
G	16"	18"
H	6"	8"
I	6"	8"

NEXGEN-FYRE™ WOOD STOVES





ROCKPORT™ HYBRID-FYRE®

Cast Iron Beauty, Built to Last!

The Rockport™ by Lopi® combines beautiful European castings with optimum performance and solid construction to bring you the perfect mid-sized wood stove. Premium materials like iron, steel, real masonry brick and crystal clear ceramic glass are brought together in a fusion of classic elegance and durability designed to heat your home and family for years to come, even when the power goes out. The Rockport features Hybrid-Fyre® technology, making it one of the most efficient and cleanest burning wood stoves in the world! Alcove and Mobile Home approved.

Options

- 400 CFM Convection Fan
- **GREEN START™** Igniter (See page 20)

Specifications

Emissions:	1.7 Grams Per Hour
Heating Capacity:*	Up to 2,000 Square Feet
EPA Tested BTU Range:	13,760 to 55,466 BTUs Per Hour
Real World BTUs:	<i>EPA tests to determine BTU output are achieved with a single load of wood at each burn rate. At home, you are likely to add more wood to your insert to maintain your desired comfort level. By the simple process of loading your fireplace insert with additional wood, you could achieve up to a 20% higher heat output than established during EPA testing.</i>
Efficiency:**	76.3% HHV
Construction:	Cast Iron
Glass Area:	165 sq. in (16-3/4"W x 10-3/8"T)
Maximum Burn Time:	Up to 10 Hours
Firebox Size:	2.15 Cubic Feet
Maximum Log Size:	20"
Bypass Damper:	Yes
Weight:	450 Pounds

* Heating capacity may vary depending on degree of home insulation, floor plan and ambient temperature zone of the area you live.

**As tested using B-415.1 using Cord Wood. HHV = High Heat Value

Clearances & Hearth Protection

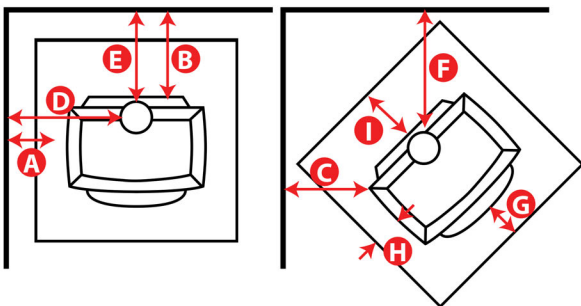

	Single Wall Connector	Double Wall Connector
A	16"	16"
B	16"	10-1/2"
C	9"	9"
D	27-1/8"	26-1/2"
E	18-1/4"	12-1/4"
F	19-1/4"	18-3/4"
	USA	Canada
G	16"	18"
H	6"	8"
I	6"	8"

HYBRID-FYRE® WOOD STOVE

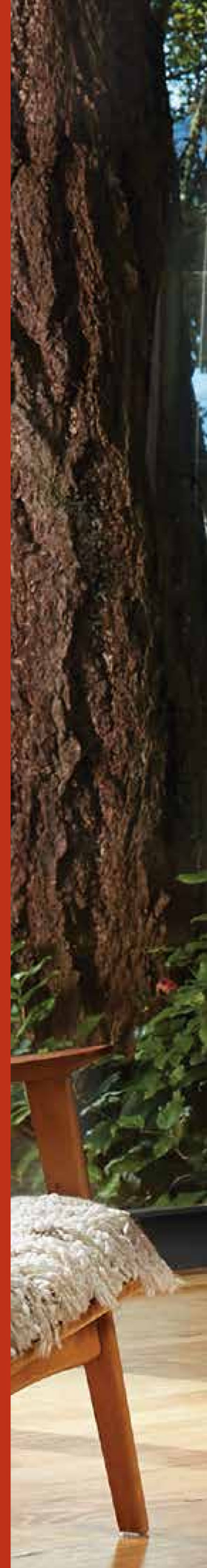





NEXGEN[®] FYRE[™]

RELIABLE, NON-CATALYTIC WOOD BURNING TECHNOLOGY. HOW IT WORKS:

- A** Pre-heated combustion air helps the glass stay clean and the stove burn efficiently.
- B** A single air control regulates the burn rate of the fire, making this advanced burner system easy to operate.
- C** Secondary air tubes combine the primary and secondary fires in the NexGen-Fyre[™] combustion system.
- D** Ceramic baffle board and insulation blanket reflect the heat to re-burn the particulate.
- E** Bypass damper allows for smoke free start-ups and reloads when open, and assists overnight burns when closed. *Not available on the Answer stove.*
- F** Room air is drawn into the convection air chamber for maximum heat transfer and efficiency. Hot air is circulated throughout the room from natural convection.
- G** With **NEXGEN[®] FYRE[™]** primary and secondary combustion are harnessed to create the ultimate blended combustion system!

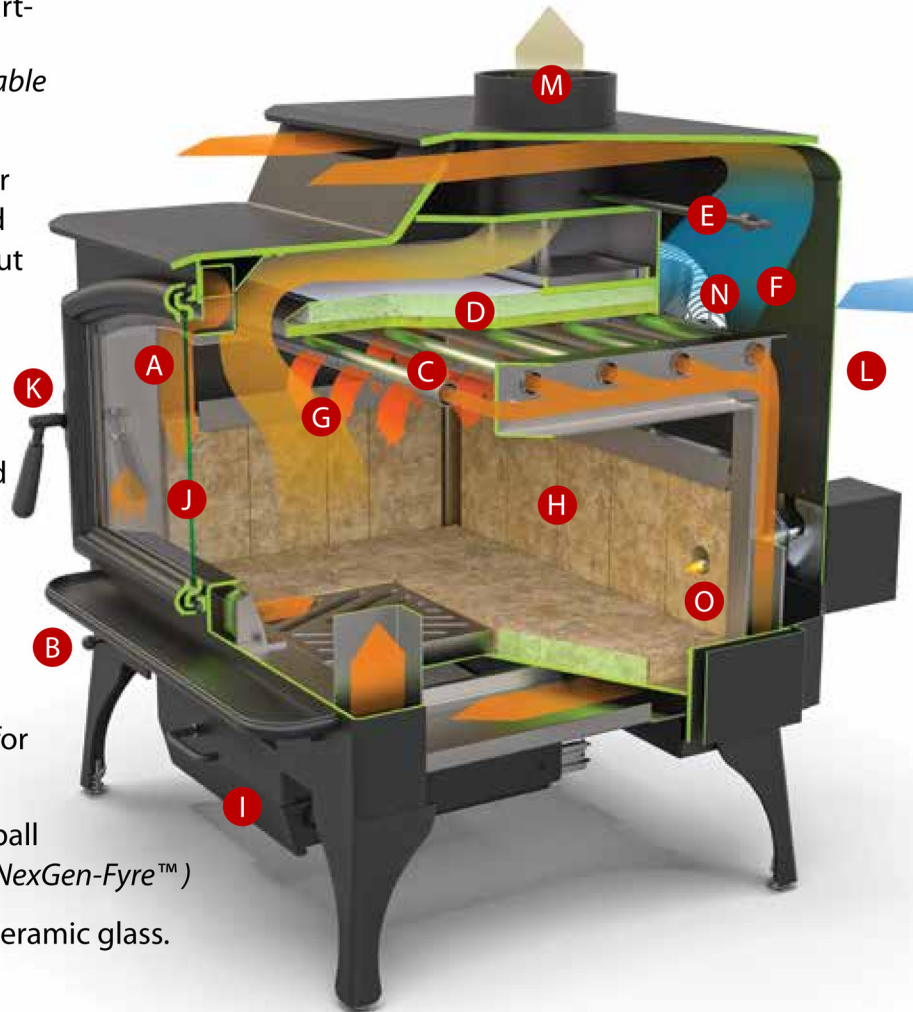

AMAZING FEATURES

- H** Fully lined masonry brick lined firebox for longevity and heat retention
- I** Easy glide large capacity ash drawer on ball bearing glides. *(Not available on Answer NexGen-Fyre[™])*
- J** Large fire-viewing door with stay clean ceramic glass.
- K** Secure locking door handle.
- L** Close rear and side wall clearance to combustibles.
- M** 6" flue allows for less costly installation.

TOP OF THE LINE ACCESSORIES

- N** A super quiet, optional fan will boost heat circulation throughout your home.
- O** Add the optional GreenStart[®] Igniter to start your fire with a push of a button. (pg. 20)

NEXGEN[®] FYRE[™]

BROUGHT TO YOU BY LOPI[®], NORTH AMERICA'S FAVORITE FIRE FOR OVER FOUR DECADES!

HYBRID[®] FYRE[®] CLEAN-BURN TECHNOLOGY. THE ROCKPORT™ IS ONE OF THE GREENEST STOVES EVER! HOW IT WORKS:

- A** Pre-heated combustion air helps the glass stay clean and the stove burn efficiently.
- B** A single air control regulates the burn rate of the fire, making this advanced burner system easy to operate.
- C** Secondary air tubes combined with an insulated baffle slow down the fire and re-burn the particulate.
- D** A durable, large catalytic combustor incinerates any left over particulate, burning up to 99.5% of the flue gases and all but eliminating any carbon monoxide.
- E** Bypass damper allows for smoke free start-ups and reloads when open, and assists overnight burns when closed.
- F** Room air is drawn through the cast iron air convection chamber for maximum heat transfer and efficiency. Hot air is circulated through your room through natural convection.

All This Equals:

HYBRID[®] FYRE[®]

The cleanest burning, most efficient wood stoves ever made.

AMAZING FEATURES

- G** Easy glide large capacity ash drawer on ball bearing glides.
- H** Large fire-viewing door with stay clean ceramic glass.
- I** Outside air connection (concealed).
- J** Secure locking door handle.
- K** Close rear and side wall clearance to combustibles.
- L** 6" flue allows for less costly installation.

TOP OF THE LINE ACCESSORIES

- M** A super quiet, massive, optional 400 CFM fan will boost heat circulation throughout your home.
- N** Add the optional GreenStart[®] Igniter to start your fire with a push of a button. (pg. 20)



Popular Mechanics[®] Wood Stove Challenge Finalist and Winner of the Peoples Choice Award.

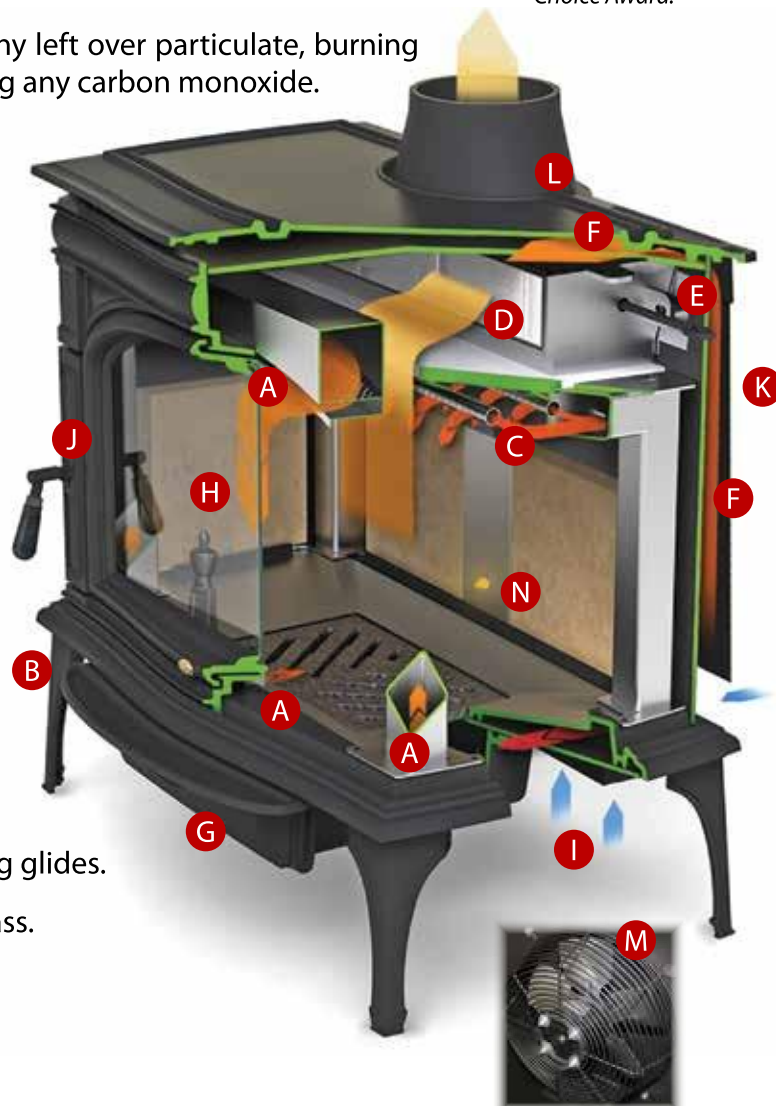

Optional rear mounted 400 CFM fan

HYBRID[®] FYRE[®]

**BROUGHT TO YOU BY LOPI[®], NORTH AMERICA'S FAVORITE FIRE
FOR OVER FOUR DECADES!**

GREEN START™

PUSH BUTTON START UP, THE GREATEST WOOD STOVE OPTION EVER!

Starting your wood stove has never been easier. Much like Charles Kettering's invention of the electric automobile ignition 100 years ago, the GreenStart igniter system has evolved the ignition of fire in a spectacular way and has become the greatest innovation in wood heating in over 100 years.



1 Simply load your wood into the firebox, close the door, and push the GreenStart™ button to begin!



2 A compressor will force 1,400 degree preheated air into the firebox directly onto the wood, giving a clean, fast, smoke-free start up within 30 seconds.



3 The igniter will then turn off and a blower will continue to push air, acting as a bellows to fan the fire.



4 The blower will fan the fire at various speeds to deliver proper draft and greatly accelerate the startup time.



5 After 15 minutes the blower will shut off and you will have a beautiful, roaring fire. The fire can be maintained over time by adjusting the bypass damper and air control.

**THE GREENSTART® IGNITER IS AN
OPTIONAL FEATURE WITH ALL LOPI®
STOVE MODELS IN THIS BROCHURE.**

See your authorized Lopi dealer and ask for an instore demonstration.

7-YEAR “REAL WORLD” WARRANTY

Our 7-Year Warranty offers more protection on key components than the so-called “Limited Lifetime” warranties of our competitors. Lopi builds stoves to last a lifetime.

We’ll stand behind the quality and performance of our products year after year because that’s the way we do business - and you don’t have to read the fine print for your peace of mind.

YEARS 1-2:

All parts and labor on your wood burning appliance, including blower and one-way freight allowance.



YEARS 3-5:

All parts and labor on the firebox, door assembly, air control assemblies and one-way freight allowance.

YEARS 6-7: Parts only on firebox, door and air control assemblies.

LOPI® DESIGN MY FIRE. BE YOUR OWN DESIGNER.

With our New & Enhanced online Design My Fire feature

Pick your stove, accessories, and extras then snap a photo of your room and upload it to see what your new fire will look like in your room! Visit our website at

WWW.LOPISTOVES.COM.



FREE MOISTURE METER

Testing the moisture level in your wood is a crucial, yet often ignored step when burning a fire. Wet wood creates excessive smoke and moisture in the firebox, whereas dry wood allows for a hotter, more efficient burn. Lopi includes a FREE moisture meter with your wood stove so you can ensure that you’re burning dry wood and getting the highest performance out of your stove.





LOPI WOOD STOVES



**ANSWER
NEXGEN-FYRE™**



**EVERGREEN
NEXGEN-FYRE™**



**ENDEAVOR
NEXGEN-FYRE™**

For installation specifications refer to the Owner's Manuals found on the Lopi® website www.lopistoves.com

	SMALL	MEDIUM	MEDIUM
SPECIFICATIONS			
Width	23-5/8"	28"	24"
Height (All Legs)	27-7/8"	31"	32"
Height (Pedestal)	N/A	33-1/2"	N/A
Depth	16-1/4"	20-1/4"	23-1/2"
Flue Size	6"	6"	6"
Construction	5/16" to 3/16" Steel	1/4" to 3/16" Steel	5/16" to 3/16" Steel
Weight (body w/legs)	300 lbs.	455 lbs w/Legs, 471 lbs w/Pedestal	448 lbs.
Ash Pan	No	Yes	Yes
PERFORMANCE			
Emissions	2.0 Grams/Hr.	1.5 Grams/Hr.	1.4 Grams/Hr.
Heating Capacity (Sq Ft.)	Up to 1,400	Up to 2,000	Up to 2,000
EPA Tested BTUs	12,129 to 59,527	12,772 to 70,720	15,435 to 67,090
"Real World BTUs"*	See Below	See Below	See Below
Overall Efficiency**	Up to 72.4% OHV	Up to 77.1% OHV	Up To 74.2% OHV
Maximum Burn Time	Up To 8 Hours	Up To 10 Hours	Up To 10 Hours
Firebox Size	1.5 Cubic Ft.	2.2 Cubic Ft.	2.5 Cubic Ft.
Maximum Log Size	Up To 18"	Up To 20-1/2"	Up To 18"
CLEARANCES	Single Wall Connector Double Wall Connector	Single Wall Connector Double Wall Connector	Single Wall Connector Double Wall Connector
A = Stove to Side Wall	18" 13"	12" 11"	15" 13"
B = Stove to Back Wall	16-1/2" 9"	17" 9"	17" 9"
C = Stove to Corner Wall	10" 7-1/2"	8" 4"	15" 6-1/2"
D = Connector to Side Wall	27" 21-1/2"	22-1/2" 21"	24" 21-1/2"
E = Connector to Back Wall	19-1/2" 11-1/2"	19" 10-1/2"	19-3/4" 11-1/4"
F = Connector to Corner Wall	19-1/2" 16-1/2"	17-1/2" 13-1/2"	24" 15"
HEARTH PROTECTION	USA CANADA	USA CANADA	USA CANADA
G = Front	16" 18"	16" 18"	16" 18"
H = Sides	6" 8"	6" 8"	6" 8"
I = Back	6" 8"	6" 8"	6" 8"
ALCOVE	Combustible Non Combustible	Combustible Non Combustible	Combustible Non Combustible
J = Minimum Width	49-5/8" 35-5/8"	50" 40"	50" 36"
K = Maximum Depth	48" 48"	48" 48"	48" 48"
L = Minimum Height	84" 34"	84" 6" above top	84" 40"

*EPA tests to determine BTU output are achieved with a single load of wood at each burn rate. At home, you are likely to add more wood to your stove to maintain your desired comfort level. By the simple process of loading your stove with additional wood, you could achieve up to a 20% higher heat output than established during EPA testing.

** Overall Efficiency as tested using B-415.1 using Cord Wood. OHV = Overall Heat Value.

CLEARANCES TO UNPROTECTED COMBUSTIBLES

Use these illustrations in conjunction with the information under the "Clearance" & "Alcove" headings above.

Heating Capacity may vary depending on degree of home insulation, floor plan and ambient temperature zone of the area in which you live.

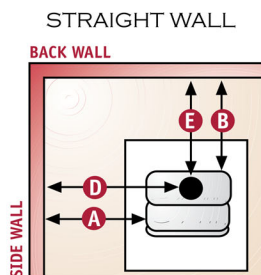

INSTALLATIONS CORNER WALL

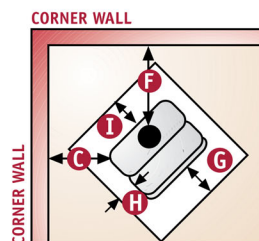

ALCOVE

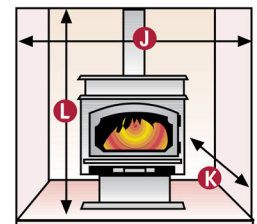

For installation specifications refer to the Owner's Manuals found on the Lopi® website www.lopistoves.com



**LIBERTY
NEXGEN-FYRE™**



**ROCKPORT
HYBRID-FYRE™**

	LARGE		MEDIUM	
SPECIFICATIONS				
Width	30"		28-1/4"	
Height (All Legs)	34-3/16"		31-1/2"	
Height (Pedestal)	N/A		N/A	
Depth	24-9/16"		19-3/4" (21-3/4" w/heat shield)	
Flue Size	6"		6"	
Construction	5/16" to 3/16" Steel		5/16" to 3/16" Steel	
Weight (body w/legs)	570 lbs.		Cast Iron - 450 lbs.	
Ash Pan	Yes		Yes	
PERFORMANCE				
Emissions	2.5 Grams/Hr.		1.7 Grams/Hr.	
Heating Capacity (Sq Ft.)	Up to 2,500		Up to 2,000	
EPA Tested BTUs	15,155 to 63,239		13,760 to 55,466	
"Real World BTUs"*	See Below		See Below	
Overall Efficiency **	Up To 70% OHV		Up to 76.3% OHV	
Maximum Burn Time	Up To 12 Hours		Up To 10 Hours	
Firebox Size	3.65 Cubic Ft.		2.15 Cubic Ft.	
Maximum Log Size	Up To 24"		Up To 20"	
CLEARANCES				
	Single Wall Connector	Double Wall Connector	Single Wall Connector	Double Wall Connector
A = Stove to Side Wall	16"	16"	16"	16"
B = Stove to Back Wall	15"	10"	16"	10.5"
C = Stove to Corner Wall	9-1/2"	7-1/2"	9"	9"
D = Connector to Side Wall	28"	27-1/2"	27-1/8"	26-1/2"
E = Connector to Back Wall	18-1/4"	12-3/4"	18-1/4"	12-1/4"
F = Connector to Corner Wall	21	18-1/2"	19-1/4"	18-3/4"
HEARTH PROTECTION				
	USA	CANADA	USA	CANADA
G = Front	16"	18"	16"	18"
H = Sides	6"	8"	6"	8"
I = Back	6"	8"	6"	8"
ALCOVE				
	Combustible	Non Combustible	Combustible	Non Combustible
J = Minimum Width	62"	42"	60-1/4"	40-1/4"
K = Maximum Depth	48"	48"	48"	48"
L = Minimum Height	84"	42-3/8"	84"	37-1/2"

*EPA tests to determine BTU output are achieved with a single load of wood at each burn rate. At home, you are likely to add more wood to your stove to maintain your desired comfort level. By the simple process of loading your stove with additional wood, you could achieve up to a 20% higher heat output than established during EPA testing.

** Overall Efficiency as tested using B-415.1 using Cord Wood. OHV = Overall Heat Value.

TRAVIS WOOD BURNING FIREPLACES, INSERTS AND STOVES ARE PROTECTED BY ONE OR MORE OF THE FOLLOWING PATENTS; U.S. 9,170,025, 4,665,889 AS WELL AS OTHER U.S. AND FOREIGN PATENTS PENDING.

Only the most professional specialty hearth retailers are selected to sell Lopi® stoves and inserts. They represent our total commitment to exceptional products and excellent service. In addition, they have successfully completed special training programs in the proper selection, installation, and service of all Lopi® products.

Your professional Lopi hearth dealers are experts who can advise you on everything from customizing the color of your appliance to selecting appropriate venting and chimney materials. They can show you Lopi® models on display, including working models actually burning.

KEEP THEM WARM, KEEP THEM SAFE



Children, like most of us are fascinated by fire and for families with young children, fireplaces pose a potential safety hazard. Take the time to educate young children about the dangers of fire and the hot surface temperatures of glass and metal surrounding the wood burning appliance. If you have an infant or toddler consider installing a firescreen; make sure it's tall enough so that children can't climb over it, and that it's placed far enough away so that reaching arms can't touch the surfaces of the fireplace. A few precautions such as these will allow everyone in your home to safely enjoy the comfort and warmth of your new stove.

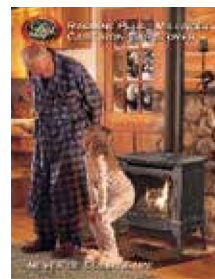
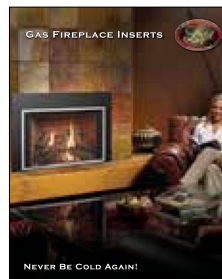
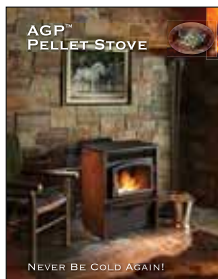

Lopi® produces a wide variety of quality wood, pellet, and gas hearth appliances.

Find your favorite fire today by visiting: www.lopistoves.com

YOUR LOPi AUTHORIZED DEALER:



www.lopistoves.com
Manufactured in
Mukilteo, WA

