

SR Smith®

POOL SLIDES



Pool **Better**™

POOL SLIDES

CONTENTS

Overview	4
Removable Deck Slide.....	6
Deck Mounted Slides.....	8
Custom Slides.....	14

SLIDE INTO FUN

For hours of serious sliding fun, look to S.R. Smith. Manufactured from high-quality corrosion-resistant material, S.R. Smith pool slides are engineered to deliver serious fun, season after season! From the towering Vortex® with its 19' corkscrew runway, to the removeable SlideAway with its big personality, we have a slide that will transform your swimming pool into a favorite destination for kids of all ages.

LET IT FLOW

S.R. Smith pool slides, with integrated water delivery systems, offer high-volume water fun for a slippery, sloshy ride. The 360 degree heliX2® slide has a patented water fountain feature positioned at the top of the slide that provides splashing good fun from top to bottom!

SALT POOL FRIENDLY

We know pool builders and consumers alike enjoy the benefits of salt chlorinator systems - that's why we've designed a line of products that perform well in salt pool environments. Our Salt Pool Friendly icon is your visual assurance that the most durable and salt friendly materials have been used in manufacturing.



POOL SLIDE SAFETY

All S.R.Smith Swimming Pool Slides are independently tested and verified to be fully CPSC compliant.

PROTECT YOUR BUSINESS: INSTALL CPSC COMPLIANT SLIDES

Protect your livelihood and ensure your customer's safety. Install slides that fully comply with the U.S. Consumer Product Safety Commission's (CPSC) Safety Standard for Swimming Pool Slides (16 CFR Part 1207). The CPSC is an independent government regulatory agency that exists to protect the public from risk of injury and death associated with consumer products. For more information, visit cpsc.gov.

CPSC STANDARD FOR SWIMMING POOL SLIDES 16 CFR PART 1207

The CPSC Standard requires passing 48 unique performance tests and outlines requirements concerning manufacturing construction and materials. The CPSC also makes recommendations regarding handling, storage, marking and installation. Swimming pool slides must meet all applicable standard requirements to fully comply.



CPSC TESTING



Sample Test RUNWAY EQUILIBRIUM
The slide trajectory is recorded by a marker that is attached to a weighted block, released from the top of the slide. This tests for a consistent slide path exit.

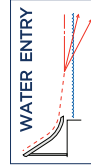

Sample Test WATER ENTRY
The path of the potential slider is digitally recorded by high speed video cameras. The data is analyzed to ensure the slider does not enter the water at an angle that is likely to cause impact with the bottom of the pool.

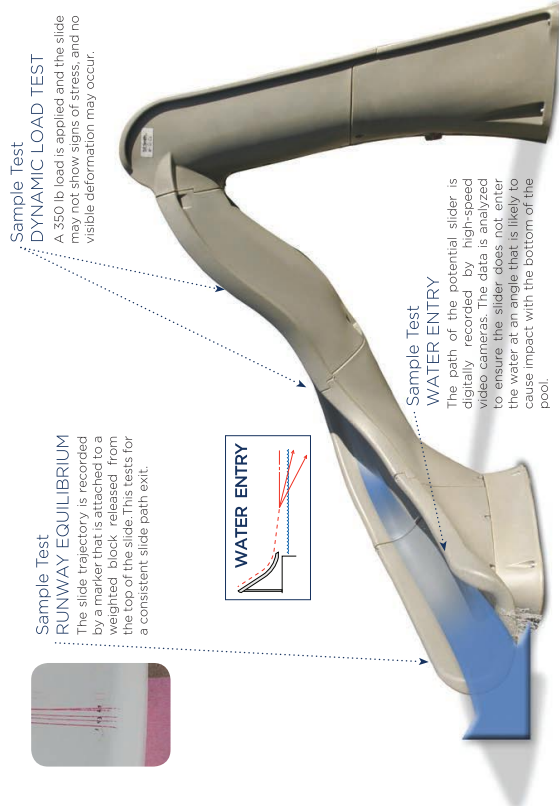

Sample Test DYNAMIC LOAD TEST
A 350 lb load is applied and the slide may not show signs of stress, and no visible deformation may occur.

Slide Placement Guidelines (Removable and Deck Mounted Slides)

The pool industry association has provided these guidelines for slide placement. Our slides can be mounted directly to the deck making retrofit applications easy (check with your inspector for local codes and guidelines). From the top of the ladder, a flume that curves down to the left is a left curve slide, and a flume that curves down to the right is a right curve slide.

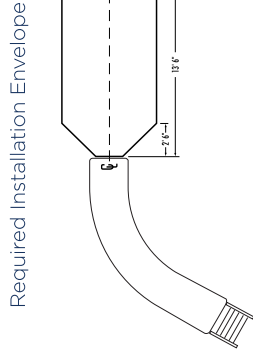
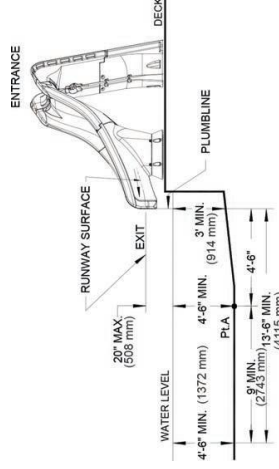

Assemble. Install. Slide.

See how simple it is to assemble and install all of our deck mounted pool slides with our installation videos. Go to srmith.com or visit the S.R.Smith YouTube channel.



Please note the installation of this product should be done only by a licensed and professional installer. Installation should be done strictly in conformance with all local building codes, electrical codes and other building and all safety laws and regulations.

For more information on the standard, visit http://www.access.gpo.gov/hara/cfr/cfrn1207_04.html. To view S.R.Smith compliance documents, visit srmith.com/en/safety



The Safe Removable Pool Slide

Introducing SlideAway®, the safe removable in-ground pool slide from S.R.Smith. SlideAway combines safety, fun and durability in a slide that can be easily set-up and removed from the deck in just minutes. SlideAway is the first fully CPSC compliant pool slide that doesn't have to be permanently affixed to the pool deck.

Designed to resist fading, SlideAway is salt pool friendly and comes in colors that will compliment any outdoor living space. SlideAway is ideal for children up to 125 lbs. and will provide hours of splashing fun!



SlideAway® REMOVABLE POOL SLIDE

- First CPSC compliant removable and portable pool slide, meeting federal safety standards for 48 individual tests (Taupe and Gray)
- Available in colors to compliment the pool and patio areas
- Comes partially assembled and includes an easy to use dolly to roll SlideAway on and off the pool deck
- 3' x 67" deck space required
- Easy to set-up and store away in shed or garage
- Fully rotomolded construction provides strength and durability for years to come
- Enclosed, textured steps and integrated hand-holds for added safety
- Designed for children up to 125 lbs/57 kg
- Salt pool friendly
- Built-in UV inhibitors to resist fading
- Intended for in-ground residential swimming pools only
- Made in the USA

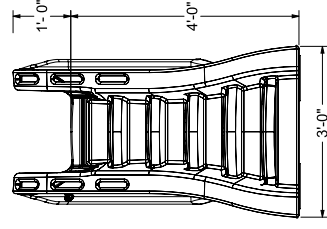
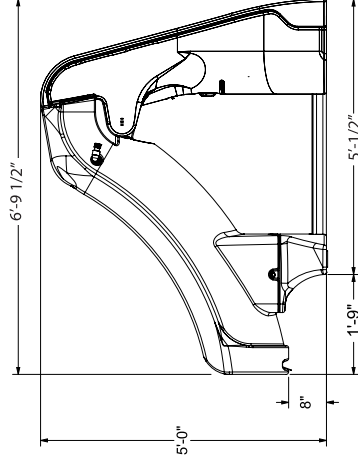

Part No.	Description
SHIPPING	155 lbs - 39"L x 54"W x 89" H 70 kg - 99cm x 137cm x 226cm
660-209-5810	SlideAway Removable Pool Slide - Taupe
660-209-5820	SlideAway Removable Pool Slide - Gray

ROGUE2

DECK MOUNTED POOL SLIDE



A retro look with a thoroughly modern, rotomolded flume makes this the new standard for backyard fun.

- 8' in height (6'6" to seat)
- Available in right or left curved flume
- Accommodates sliders up to 250 lbs/113kg
- Wide flume with high walls
- Designed for quick, easy assembly
- Improved high volume water delivery system can be plumbed through the pool's return line or connected to a garden hose
- Can be surface or in-deck mounted to accommodate any pool
- Flanges are included with the slide kit
- Intended for in-ground residential swimming pools only
- Made in the USA

Slide Color

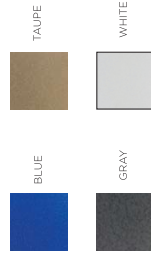

Due to printing technology, actual color may differ. Adult supervision required at all times when children are using this slide.

Flume Details

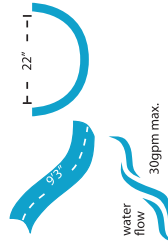

Part No.	Description
SHIPPING CLASS 300	190 lbs - 41"L x 36"W x 92" H 91 kg - 104cm x 91cm x 234cm
610-209-5812	White, Right Curve
610-209-5822	White, Left Curve
610-209-5810	Taupe, Right Curve
610-209-5820	Taupe, Left Curve
610-209-5813	Blue, Right Curve
610-209-5823	Blue, Left Curve
610-209-58120	Gray, Right Curve
610-209-58220	Gray, Left Curve

PARTS & ACCESSORIES

- 75-209-5866 Aluminum Flange Anchor Kit
- 75-209-5865 Plastic Deck-Mounted Anchor Flange Kit
- 75-209-5000 White Aluminum Flange Anchors (4)
- 75-209-5702 White Aluminum Flange (1)

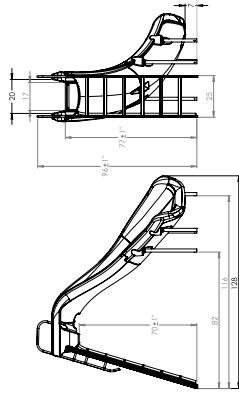

All S.R.Smith, LLC swimming pool slides fully comply with Consumer Products Safety Commission (CPSC) mandatory safety Standard for Swimming Pool Slides (16 CFR 1207) and are certified by independent third party testing labs. The installer or end-user is responsible for complying with local building codes for the location, installation, construction or assembly of these slides. S.R.Smith, LLC makes no representations that the location, installation, construction or assembly of its slides meet local building codes.

helix2

DECK MOUNTED POOL SLIDE

A new generation of S.R.Smith's popular pool slide is here—introducing the helix2*!

- Deeper 360° corkscrew flume for fast and safe sliding
- Patented water feature delivery system for a dramatic fountain feature
- 74" in height (6'5 1/2" to seat)
- Accommodates sliders up to 250 lbs/113kg
- Sturdy rotomolded construction – for strength and durability
- Enclosed ladder and molded handrail design for maximum safety
- Designed for quick and easy assembly with simple deck mounted installation
- Water delivery system can be plumbed through the pool's return line or connected to a garden hose
- Intended for in-ground residential swimming pools only
- Made in the USA



Slide Color

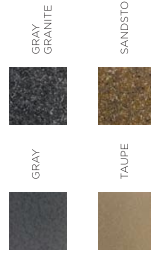

Due to printing technology, actual color may differ. Adult supervision required at all times when children are using this slide.



*Gray Granite and Sandstone slides are not an exact match with Gray Granite or Sandstone diving boards & stands due to differences in material. Please consult your sales representative for more details.

Part No.	Description
SHIPPING CLASS 300	390 lbs - 66"L x 88"W x 48" H 177 kg - 167cm x 223cm x 122cm
640-209-58124	Gray Granite*
640-209-58123	Sandstone*
640-209-58120	Solid Gray
640-209-58110	Solid Taupe

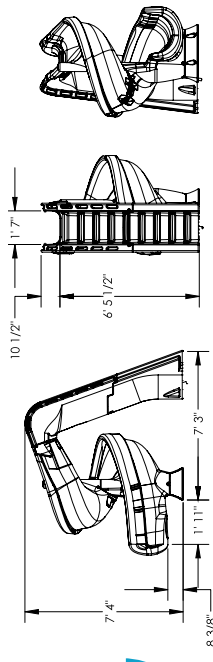
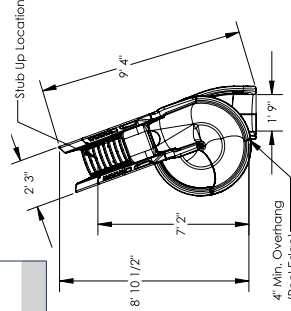

All S.R.Smith, LLC swimming pool slides fully comply with Consumer Products Safety Commission (CPSC) mandatory safety Standard for Swimming Pool Slides (16 CFR 1207) and are certified by independent third party testing labs. The installer or end-user is responsible for complying with local building codes for the location, installation, construction or assembly of these slides. S.R.Smith, LLC makes no representations that the location, installation, construction or assembly of its slides meet local building codes.

TurboTwister®

DECK MOUNTED POOL SLIDE



This thrill-ride pool slide is designed with curves and dips that guarantee hours of fun for the entire family.

- 8.7" in height (71 5/8" to seat)
- Available with a right or left curved flume
- Accommodates sliders up to 275 lbs/124kg
- Sturdy rotomolded construction for strength and durability
- Enclosed ladder and molded handrail design for maximum safety
- Designed for quick and easy assembly
- 25 gpm max. water delivery system can be plumbed through the pool's return line or connected to a garden hose
- Simple deck mounted installation
- Intended for in-ground residential swimming pools only
- Made in the USA

Slide Color

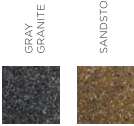

Due to printing technology, actual color may differ.
Adult supervision required at all times when children are using this slide.



Flume Details

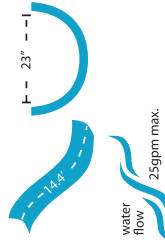

All S.R.Smith, LLC swimming pool slides fully comply with Consumer Products Safety Commission (CPSC) mandatory safety Standard for Swimming Pool Slides (16 CFR 1207) and are certified by independent third party testing labs. The installer or end-user is responsible for complying with local building codes for the location, installation, construction or assembly of these slides. S.R.Smith, LLC makes no representations that the location, installation, construction or assembly of its slides meet local building codes.



Typhoon®

DECK MOUNTED POOL SLIDE

Offers all the fun of its big brother, the TurboTwister, yet in a smaller package for more limited deck space.

- 7.4" in height (65 1/2" to seat)
- Available with a right or left curved flume
- Accommodates sliders up to 275 lbs/124kg
- Sturdy rotomolded construction - for strength and durability
- Enclosed ladder and molded handrail design for maximum safety
- Designed for quick and easy assembly
- 20 gpm max. water delivery system can be plumbed through the pool's return line or connected to a garden hose
- Simple deck mounted installation
- Intended for in-ground residential swimming pools only
- Made in the USA

Slide Color



Due to printing technology, actual color may differ.
Adult supervision required at all times when children are using this slide.



Flume Details

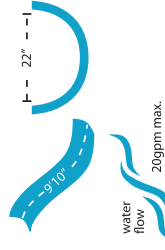

All S.R.Smith, LLC swimming pool slides fully comply with Consumer Products Safety Commission (CPSC) mandatory safety Standard for Swimming Pool Slides (16 CFR 1207) and are certified by independent third party testing labs. The installer or end-user is responsible for complying with local building codes for the location, installation, construction or assembly of these slides. S.R.Smith, LLC makes no representations that the location, installation, construction or assembly of its slides meet local building codes.

Part No.	Description
SHIPPING CLASS 300	270 lbs - 56"L x 31"W x 92"H 123 kg - 142cm x 79cm x 234cm
670-209-58123	Sandstone*, Right Curve
670-209-58223	Sandstone*, Left Curve
670-209-58124	Gray Granite*, Right Curve
670-209-58224	Gray Granite*, Right Curve

*Gray Granite and Sandstone slides are not an exact match with Gray Granite or Sandstone diving boards & stands due to differences in material. Please consult your sales representative for more details.

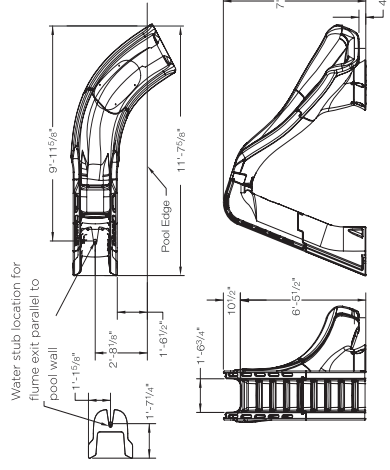



Cyclone

DECK MOUNTED POOL SLIDE

Compact style ideal for limited deck space and smaller pool enthusiasts.

- 41" in height (32" to seat)
- Available with a right curve flume only
- Accommodates sliders up to 175 lbs./79kg
- Sturdy rotomolded construction for strength and durability
- Enclosed ladder design for maximum safety
- Designed for quick and easy assembly
- Water delivery system connects to a garden hose
- Simple deck mounted installation
- Intended for in-ground residential swimming pools only
- Made in the USA

Part No.	Description
SHIPPING CLASS 300	150 lbs - 41"L x 31"W x 56"H 123 kg - 68cm x 79cm x 142cm
698-209-58123	Sandstone*, Right Curve
698-209-58124	Gray Granite*, Right Curve
698-209-58110	Taupe, Right Curve

*Gray Granite and Sandstone slides are not an exact match with Gray Granite or Sandstone diving boards, & stands due to differences in material. Please consult your sales representative for more details.

Slide Color

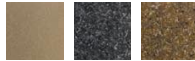

Due to printing technology, actual color may differ.

Adult supervision required at all times when children are using this slide.



Flume Details



All S.R.Smith, LLC swimming pool slides fully comply with Consumer Products Safety Commission (CPSC) mandatory safety Standard for Swimming Pool Slides (16 CFR 1207) and are certified by independent third party testing labs. The installer or end-user is responsible for complying with local building codes for the location, installation, construction or assembly of these slides. S.R.Smith, LLC makes no representations that the location, installation, construction or assembly of its slides meet local building codes.



Vortex

DECK MOUNTED POOL SLIDE

Big time, fun slide!

- 107" in height (7'6" to seat)
- 19" corkscrew runway
- Available with ladder or spiral staircase
- Accommodates sliders up to 325 lbs./147kg
- Sturdy rotomolded construction for strength and durability
- 30 gpm max. water delivery system can be plumbed through the pool's return line
- Intended for in-ground swimming pools only
- Made in the USA

Part No.	Description	Weight
SHIPPING CLASS 300	128"L x 57"W x 72"H 325cm x 145cm x 183cm 150"L x 39"W x 48"H 381cm x 99cm x 122cm	
695-209-13	Open flume with ladder, Blue	1350 lbs 612 kg
695-209-124	Open flume with ladder, Gray Granite	1500 lbs 680 kg
695-209-23	Closed flume with ladder, Blue	1500 lbs 680 kg
695-209-224	Closed flume with ladder, Gray Granite	1500 lbs 680 kg
695-209-33	Open flume with staircase, Blue	1710 lbs 776 kg
695-209-324	Open flume with staircase, Gray Granite	1710 lbs 776 kg
695-209-43	Closed flume with staircase, Blue	1860 lbs 844 kg
695-209-424	Closed flume with staircase, Gray Granite	1860 lbs 844 kg

*Gray Granite and Blue slides are not an exact match with Gray Granite or Sandstone diving boards & stands due to differences in material. Please consult your sales representative for more details.

Parts & Accessories

- 14-400 Warning Sign and Rules Sign

Slide Color



Due to printing technology, actual color may differ.

Adult supervision required at all times when children are using this slide.

Flume Details

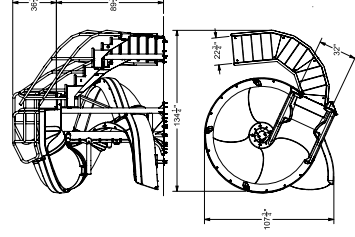
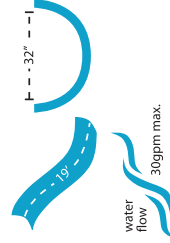

Vortex with Staircase

Vortex with Ladder



All S.R.Smith, LLC swimming pool slides fully comply with Consumer Products Safety Commission (CPSC) mandatory safety Standard for Swimming Pool Slides (16 CFR 1207) and are certified by independent third party testing labs. The installer or end-user is responsible for complying with local building codes for the location, installation, construction or assembly of these slides. S.R.Smith, LLC makes no representations that the location, installation, construction or assembly of its slides meet local building codes.



CREATE A UNIQUE BACKYARD RESORT

Give customers the pool of their dreams with a custom slide, Garden Ride, River Run and BYOS2 Slides are made using an advanced Resin Transfer Molding (RTM) process and coordinate with other RTM products. All pre-configured and unique custom slides are UV resistant, salt pool friendly and exceptionally strong and durable. For custom pool designs, provide your drawing to our technical experts and we'll work with you to make the vision a reality for your customer.

MINIMUM WEIGHT - MAXIMUM STRENGTH

Garden Ride, River Run and BYOS2 slides are made using a Resin Transfer Molding (RTM) process. RTM is an advanced manufacturing process that is used in a diverse range of applications from aerospace to automotive products. The RTM process creates a composite material that has a high strength to weight ratio – although lightweight, it is exceptionally strong and durable. RTM products offer a truly unique look that is salt pool friendly and UV resistant to protect colors from fading.



Build Your Own Slide (BYOS2™) Custom Slide

The Build Your Own Slide (BYOS2) provides easy, customized slide solutions to builders incorporating handcrafted rock work or water-park type designs into custom backyard settings. There are many colors and visual textures to choose from including many stunning granite colors that will blend well into any custom backyard design.

- Up to 7 available sections combine in endless configurations
- Residential or Commercial use
- Design and configuration assistance
- Discreet zoom flume water delivery system with perfectly matching cover plate (40 - 80 gpm)
- Sleek, beautiful and durable
- 350 pound weight limit
- Stainless Steel Hardware included
- Stainless Steel Construction Anchoring Systems included
- Available in assorted colors and visual textures
- Made in the USA
- Color matching products include: T7 Diving System, Destination Series In-Pool Furniture



Slide Color

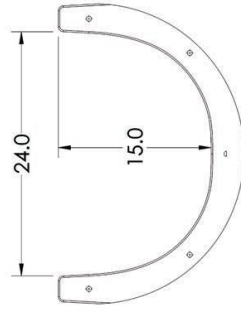
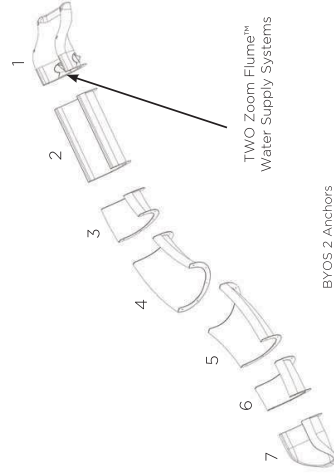
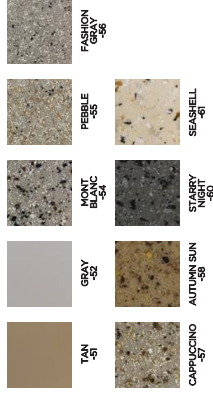

BYOS 2 Flume Dimensions

BYOS 2 Anchors
Compatible with 18"
Sonotubes*

SEND QUOTE REQUESTS TO
BYOSQUOTE@SRSMITH.COM

River Run Pre-Configured Custom Slides

River Run Slides are a collection of the most popular designs that have been custom configured through the Build Your Own Slide (BYOS2) custom landscape slide ordering process.

- Pre-Designed BYOS2™ slide kits
- Right and left turn slides
- Discreet zoom flume water delivery system with perfectly matching cover plate (20 - 40 gpm)
- 19', 23', 24' & 29' length options
- 350 pound weight limit
- No quote process needed - easy to order
- Available in assorted colors and visual textures
- Made in the USA
- Color matching products include: T7 Diving System, Destination Series In-Pool Furniture



Slide Color

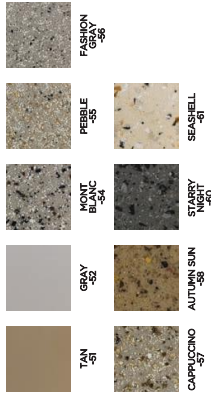

Part No.	Description
RRS19A-CL-XX	19' River Run Slide Turn A- LEFT
RRS19A-CR-XX	19' River Run Slide Turn A- RIGHT
RRS19B-CL-XX	19' River Run Slide Turn B- LEFT
RRS19B-CR-XX	19' River Run Slide Turn B- RIGHT
RRS23A-CL-XX	23' River Run Slide Turn A- LEFT
RRS23A-CR-XX	23' River Run Slide Turn A- RIGHT
RRS24A-CL-XX	24' River Run Slide Turn A- LEFT
RRS24A-CR-XX	24' River Run Slide Turn A- RIGHT
RRS24B-CL-XX	24' River Run Slide Turn B- LEFT
RRS24B-CR-XX	24' River Run Slide Turn B- RIGHT
RRS29A-CL-XX	29' River Run Slide Turn B- LEFT
RRS29A-CR-XX	29' River Run Slide Turn B- RIGHT

REPLACE THE XX IN THE PART NUMBERS TO INDICATE COLOR CODE WHEN ORDERING.

19 LINEAR FEET RIVER RUN
Style 19A - Left Turn Shown

Front View

Style 19A - Isometric View

4 BYOS 2 Anchors Supplied

19 LINEAR FEET RIVER RUN
Style 19B - Left Turn Shown

Front View

Style 19B - Isometric View

4 BYOS 2 Anchors Supplied

23 LINEAR FEET RIVER RUN
Style 23A - Left Turn Shown

Front View

Style 23A - Isometric View

4 BYOS 2 Anchors Supplied

24 LINEAR FEET RIVER RUN
Style 24A - Left Turn Shown

Front View

Style 24A - Isometric View

4 BYOS 2 Anchors Supplied

24 LINEAR FEET RIVER RUN
Style 24B - Left Turn Shown

Front View

Style 24B - Isometric View

4 BYOS 2 Anchors Supplied

29 LINEAR FEET RIVER RUN
Style 29A - Left Turn Shown

Front View

Style 29A - Isometric View

5 BYOS 2 Anchors Supplied

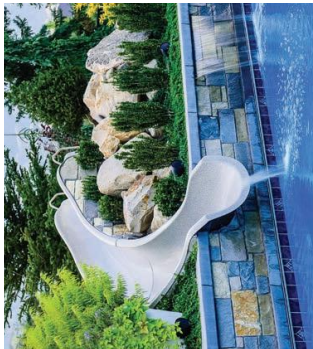

Garden Ride Pre-Configured Custom Slides

Garden Ride Pre-Configured Custom Slides are designed to be built into custom pool side landscape with limited space. Featuring an easy to assemble two-piece flume available in 10' or 15' lengths, the Garden Ride offers hours of custom splashing fun. The advanced water delivery system, a deep and wide runway, and multiple color options make it ideal for range of pool configurations.

- Right and left turn slides
- 350 pound weight limit
- Discreet zoom flume water delivery system with perfectly matching cover plate (20 - 40 gpm)
- No quote process needed - easy to order
- Matching powder coated handrails are standard
- Available in assorted colors and visual textures
- Stainless Steel Anchoring System is included to ensure proper installation
- Made in the USA
- Color matching products include: T7 Diving System, Destination Series In-Pool Furniture



Slide Color

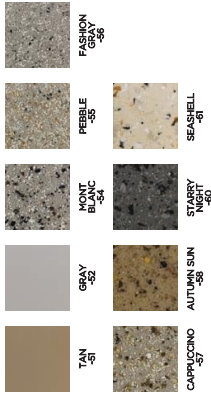

10' GARDEN RIDE (left curve shown)
Part # GRS10-CL-XX
Comes w/ stainless steel hardware and support system

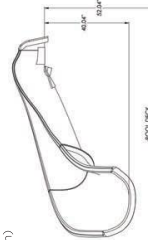

15' GARDEN RIDE (left curve shown)
Part # GRS15-CL-XX
Comes w/ stainless steel hardware and support system

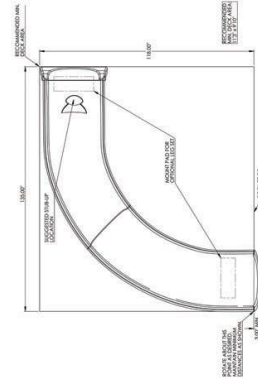
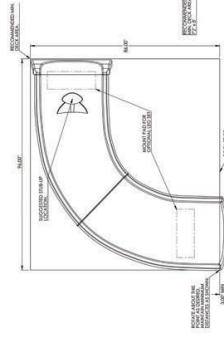
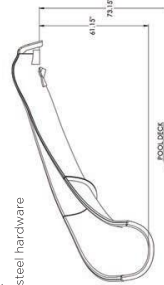

BigRide™ Custom Slide

With its long, extra deep runway and cascades of rushing water, the BigRide is a perfect landscape slide.

- 5'6" in height
- Available with a right or left curved flume
- Accommodates sliders up to 250 lbs/113kg
- 30 gpm max. water delivery system can be plumbed through the pool's return line
- Heavy-duty fiberglass gelcoat construction for maximum durability
- Designed for quick, easy assembly with a 3-piece flume for easy assembly and shipping
- Intended for in-ground residential swimming pools only
- Made in the USA



Slide Color



Due to printing technology, actual color may differ.
Adult supervision required at all times when children are using this slide.

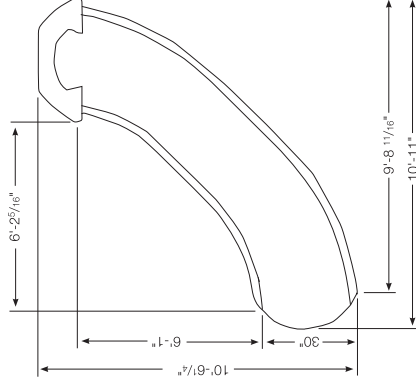

Flume Details

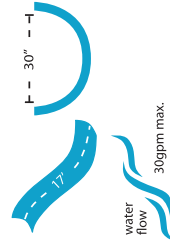

All SRSmith, LLC swimming pool slides fully comply with Consumer Products Safety Commission (CPSC) mandatory safety Standard for Swimming Pool Slides (16 CFR 1207) and are certified by independent third party testing labs. The installer or end-user is responsible for complying with local building codes for the location, installation, construction or assembly of these slides. SRSmith, LLC makes no representations that the location, installation, construction or assembly of its slides meet local building codes.



Pool Better™



A Fluidra Brand | srsmith.com | 800.824.4387

©Copyright 2022 SRSmith, LLC. All rights reserved.
No part of this may be copied or reproduced without the expressed written consent of SRSmith, LLC
M-E-BRO-310 | 5M 1122