

SRSmith

RAILS+ LADDERS

Pool|Better™



RAILS + LADDERS



CONTENTS

- Overview 4
- Modern Rails..... 6
- Rails.....12
- ADA Rails19
- Ladders21

UNIQUE DESIGN ELEMENTS THAT MAKE A POOL SPECIAL

When you choose S.R.Smith, you are choosing ladders and rails that can turn an ordinary pool into the extraordinary. From standard to custom, in a wide range of finishes, our rails can add both form and function to any pool. Modern Rails are also an ideal choice for pool renovation and new construction.

CUSTOM RAILS— ANY SIZE OR SHAPE

Whether it's a minor variation to one of our standard rail configurations, or something from your own imagination, look to S.R.Smith to help make your vision a reality. While it's true that ladders and rails should be hardworking and functional, they also have the power to help make your pool an architectural masterpiece. What's more, S.R.Smith keeps your project on track with the fastest turnaround time in the industry. We offer a variety of options so every rail will be built to your exact specifications. Visit our online rail configurator for help at srsmith.com/customrails

TUBING OPTIONS

WALL THICKNESS	304 STAINLESS STEEL	316L STAINLESS STEEL
.049"	1.625" & 1.90" OD	1.90" OD
.065"	1.50" & 1.90" OD	1.50" & 1.90" OD
.109"	1.90" OD	1.90" OD
.120"	1.50" OD	1.50" OD
.145"	1.90" OD	

A FINISH FOR EVERY POOL

A variety of finish options are available which provide a higher level of protection to our marine grade stainless steel rails and ladders. Coatings are available in a variety of colors.

POLISHED STAINLESS STEEL

304 is standard, or marine grade (316L) is an option for a higher level of protection in extreme environments.



STAINLESS STEEL

POWDER COATING

A durable finish that is easy to maintain, corrosion and scratch resistant, and is available in a wide variety of colors.



SEALEDSTEEL® SALT FRIENDLY

A protective vinyl coating that completely encapsulates the steel, and performs well in salt pool and other harsh environments (not available as a standard option, contact customercare@srsmith.com).

Note: SealedSteel cannot be used in spas and pools where the water temp exceeds 100 degrees F.



Due to printing technology, actual colors may vary.
*Custom Order Colors

RAILS AND LADDERS

Our ladders and rails are available with a variety of options:*

- Tubing sizes: 1.50", 1.625" or 1.90" OD
- Wall thicknesses: .049", .065", .109", .120", .145"
- Stainless Steel: 304 or 316L
- Coatings: SealedSteel Salt Friendly or Powder Coating

	OUTDOOR POOL		INDOOR POOL	
	Traditional Chlorinator	Salt Chlorinator	Traditional Chlorinator	Salt Chlorinator
SealedSteel	■	■	■	■
Powder Coating	■	■	■	
Marine Grade	■	■		
Stainless Steel	■			

*Not all options are available on all ladders and rails. Please visit our website for more information.

MODERN RAIL SERIES

The modern rail series are designer inspired rail lines that provide an elegant custom look for any pool environment. They are the ideal choice for pool renovation projects and new construction.

- 1.90" OD tubing
- .065" wall thickness
- 304 or 316L stainless steel
- Ladder features stainless steel treads
- Contact S.R.Smith for powder coating option

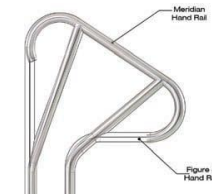

Overlay of MER-1001S and Figure 4 Hand Rail

MODERN RAIL MODEL	EASILY REPLACES
Hand Rail	Figure 4
Ladder	24" 3-Step Ladder
Stair Rail	5' 2-Bend or 5' 3-Bend Stair Rails
Deck-Mounted Stair Rail	DMS-100, 101, 102 & 103
Deck-Mounted Hand Rail	Deck-Mounted Rail 50-902

*Not available in Meridian Series

ADA COMPLIANT RAILS

S.R.Smith's rail line has been expanded to include ADA compliant transfer rails and hand rails. Designed to meet the specifications issued as part of the update to the ADA law, our ADA rails help meet government specifications, and provide pool users an easy transition into the pool.



STAIR RAILS

- Height: 34"
- Diameter: 1.90" OD
- Extends at least 12" beyond the top and bottom of the stair landing



3-Bend Hand Rail



Extended 2-Bend Hand Rail

TRANSFER RAILS

- Height: 5.75"
- Length: 12", 14", 16" or 18"
- Meets ADA structural strength requirements



Straight Transfer Rail with flanges



Bent Transfer Rail with flanges



Artisan Series MODERN RAILS

The Artisan Series is a patent pending designer inspired rail line that provides an elegant custom look for any pool environment. They are the ideal choice for pool renovation projects.

- Wall Thickness: .065"
- Stainless Steel: 304 or 316L Marine Grade* (add -MG to part number)
- Treads (Ladder Only): LTDF-103 Stainless Steel
- Recommended anchors: AS-100P or AS-100B (order separately)
- Recommended escutcheon: EP-100F (order separately)
- * Minimum requirement for salt pools is 316L Marine Grade.

Part No.	Description	Weight	Shipping		
			Length	Width	Height
ART-1001S	Single Deck Rail	15 lbs 7kg	49" 125cm	39" 99cm	2" 5cm
ART-1001	Deck Rail (pair)	30 lbs 14kg	49" 125cm	39" 99cm	5" 13cm
ART-1002	Ramp/Stair Rail (single)	25 lbs 11kg	84" 213cm	70" 177cm	2" 5cm
ART-1003	Ladder, 3 Step	40 lbs 18kg	78" 198cm	41" 104cm	2" 5cm
ART-1004	Deck-Mounted Stair Rail (single)	20 lbs 9kg	70" 178cm	39" 99cm	2" 5cm
ART-1005	Deck-Mounted Hand Rail (pair)	40 lbs 18kg	78" 198cm	41" 104cm	5" 13cm

Hand Rail (ART-1001)

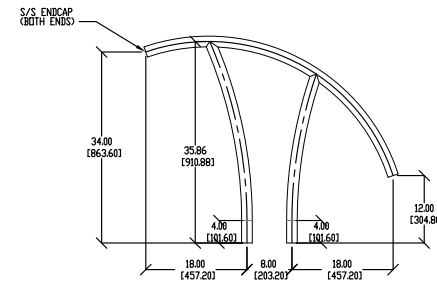

Stair Rail (ART-1002)

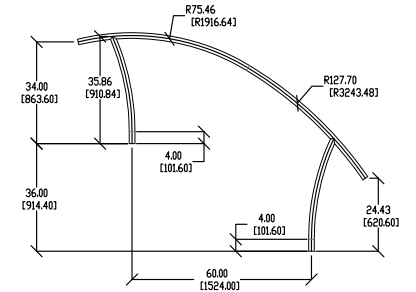

Ladder (ART-1003)

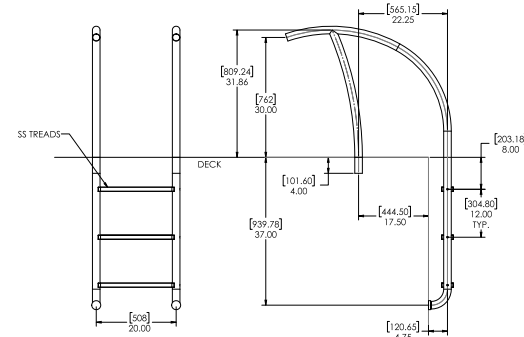

Deck-Mounted Stair Rail (ART-1004)

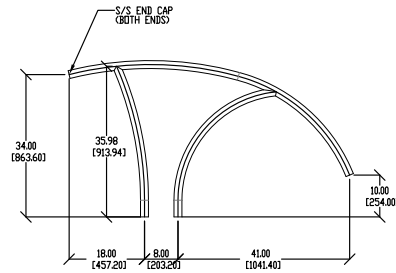

Deck-Mounted Hand Rail (ART-1005)

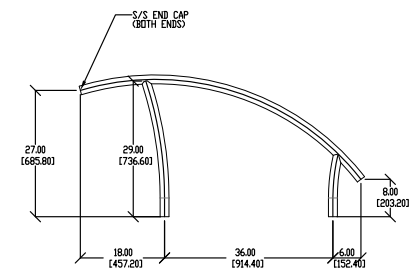

May be available in Powder-Coated or SealedSteel® finishes. Please reach out to customer-care@srsmith.com to confirm the color and finish availability.

Note: Leg lengths on all Artisan rails include 4" to go into anchors.



Meridian Series MODERN RAILS

The Meridian Series is a patent pending designer inspired rail line that provides an elegant custom look for any pool environment. They are the ideal choice for pools with limited deck space.

- Tubing: 1.90" OD
- Wall Thickness: .065"
- Stainless Steel: 304 or 316L Marine Grade* (add -MG to part number)
- Treads (Ladder Only): LTDF-103 Stainless Steel
- Options: Powder-coating available
- Recommended anchors: AS-100P or AS-100B (order separately)
- Recommended escutcheon: EP-100F (order separately)
- * Minimum requirement for salt pools is 316L Marine Grade

Part No.	Description	Weight	Shipping		
			Length	Width	Height
MER-1001S	Single Deck Rail	18 lbs 8kg	38" 96cm	32" 81cm	4" 10cm
MER-1001	Deck Rail (pair)	32 lbs 14kg	38" 96cm	32" 81cm	4" 10cm
MER-1002	Ramp/Stair Rail (single)	21 lbs 10kg	72" 183cm	40" 10.1cm	3" 8cm
MER-1003	Ladder, 3 Step	42 lbs 19kg	77" 196cm	41" 10.4cm	4" 10cm
MER-1004	Deck-Mounted Stair Rail (single)	20 lbs 9kg	60" 152cm	38" 97cm	2" 5cm



MER-1001 - Pair



MER-1001S - Pair



MER-1002



MER-1003



MER-1004

Hand Rail (MER-1001S)

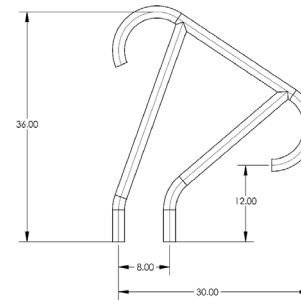

Stair Rail (MER-1002)

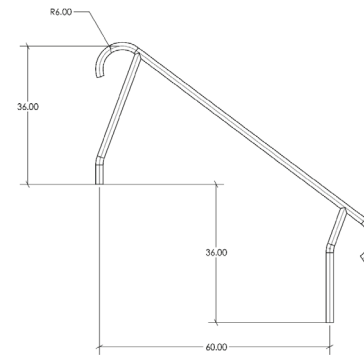

Ladder (MER-1003)

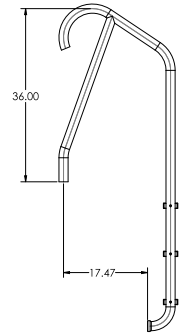
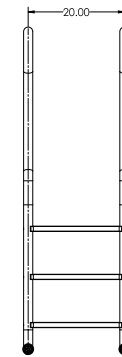

Deck Mounted Stair Rail (MER-1004)

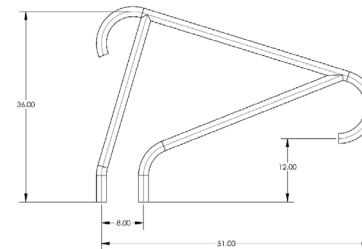

May be available in Powder-Coated or SealedSteel® finishes. Please reach out to customer@srsmith.com to confirm the color and finish availability.



Designer Series MODERN RAILS

The Designer Series can replace traditional pool rails for an upgraded sophisticated look in any pool environment.

- Tubing: 1.90" OD
- Wall Thickness: .065"
- Polished pool grade stainless steel (304 alloy), marine grade (316l alloy), and color coated
- 3 Year warranty includes: rust, fading and chipping
- Deck top mounted versions available
- Salt Pool Safe™ when rails upgraded to Powder Coating, SealedSteel® or Marine Grade
- Upgradable deck top mounted flanged versions (escutcheons included)

Custom Powder Coated Colors: White: -1; Black: -2; Taupe: -3; Copper Vein: -4; Hammetone Gray: -6; Light Gray: -9 (add custom color code behind part # when ordering)

On ALL powder coated rails, the bottom 4" of the stainless steel is NOT powder coated. If you use 3" anchors, a 3" option is available upon request.

SealedSteel® Salt Friendly Colors: White: -TPC-W; Gray: -TPC-G; Tan: -TPC-T (add custom color code behind part # when ordering)

All SealedSteel® coated rails are encapsulated in plastic coating and sealed at the ends with plastic caps.

Part No.	Description	Weight	Length	Width	Height
DR-G3D065	Grab Rail - Pair	31 lbs 14kg	37" 94cm	31" 79cm	4" 10cm
DR-G3D065-Single	Grab Rail - Single	17 lbs 8kg	38" 97cm	33" 84cm	3" 8cm
DR-D3D50065	Deck to Deck Return Stair Rail	23 lbs 10.5kg	55" 140cm	40" 102cm	3" 8cm
DR-D2D3.0065	Deck to Deck Stair Handrail	22 lbs 10kg	54" 137cm	37" 94cm	3" 8cm
DR-D2S4065	Deck to Stair Handrail - 4'	17 lbs 8kg	36" 91cm	50" 127cm	2" 5cm
DR-D2S5065	Deck to Stair Handrail - 5'	19 lbs 9kg	74" 188cm	63" 160cm	2" 5cm
DR-D2S6065	Deck to Stair Handrail - 6'	15 lbs 7kg	83" 211cm	74" 188cm	2" 5cm
DR-ADA-D2S4065	ADA Deck to Stair Handrail - 4'	18 lbs 8kg	71" 180cm	38" 97cm	3" 8cm
DR-ADA-D2S5065	ADA Deck to Stair Handrail - 5'	23 lbs 10.5kg	87" 221cm	39" 99cm	2" 5cm
DR-ADA-D2S6065	ADA Deck to Stair Handrail - 6'	32 lbs 15kg	89" 226cm	38" 97cm	3" 8cm
DR-L3065P-W	3 Tread Ladder w/HIP Tread	32 lbs 15kg	74" 188cm	29" 74cm	3" 8cm
DR-L3065S	3 Tread Ladder w/SUT Tread	35 lbs 16kg	74" 188cm	29" 74cm	3" 8cm
DR-L4065P-W	4 Tread Ladder w/HIP Tread	34 lbs 15.5kg	74" 188cm	30" 76cm	3" 8cm
DR-L4065S	4 Tread Ladder w/SUT Tread	35 lbs 16kg	74" 188cm	29" 74cm	3" 8cm
DR-COML3CB24065S	3 Tread Commercial Ladder - 24"	30 lbs 14kg	75" 190cm	43" 109cm	2" 5cm



DR-G3D065-S - Single
DR-G3D065 - Pair



DR-D3D50065



DR-D2D3.0065



DR-D2S4065 - 4' Span
DR-D2S5065 - 5' Span
DR-D2S6065 - 6' Span



DR-L3065P-W - 3 Step w/HIP Tread
DR-L3065S - 3 Step w/SUT Tread
DR-L4065P-W - 4 Step w/HIP Tread
DR-L4065S - 4 Step w/SUT Tread

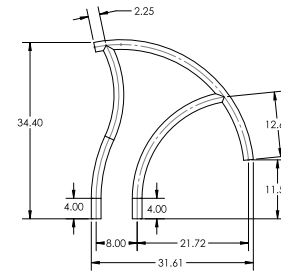

DR-G3D065-S - Single
DR-G3D065 - Pair

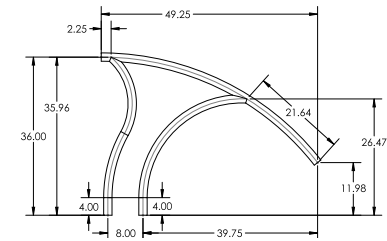

DR-D3D Deck to Deck Return Stair Rail

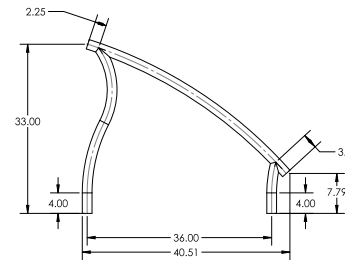

DR-D2D3 Deck to Deck Stair Handrail (pair)

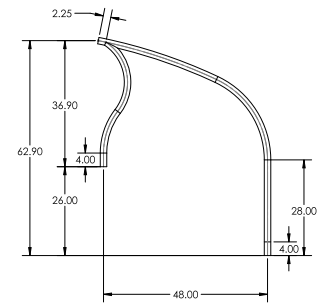

DR-D2S Deck to Stair Handrail

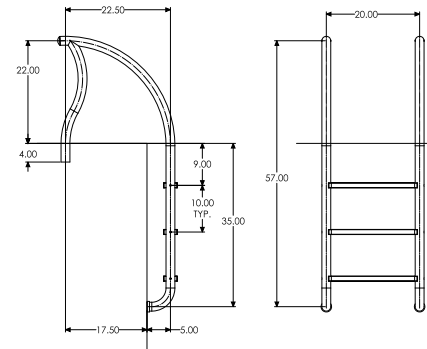

Designer 3 Tread Ladder

Deck-Mounted Hand & Stair Rails

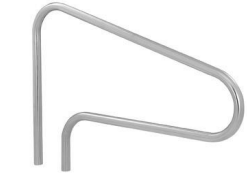

DMS-100

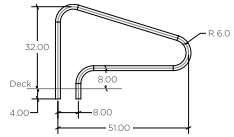

- Tubing: 1.90" OD
- Wall Thickness*: .049" or .065"
- Stainless Steel: 304 or 316L Marine Grade** (add -MG to part number)
- Bends: 6" Radius
- Recommended Anchors: AS-100P or AS-100B (order separately)
- Recommended Escutcheon: EP-100F (order separately)
- Sold as a single rail

* Minimum rail thickness is .065 for Commercial
 ** Minimum requirement for salt pools is 316L Marine Grade

DMS-100

Part No.	Description	Shipping			
		Weight	Length	Width	Height
DMS-100A	51" Center Grab Rail, .049"	18 lbs 8kg	59" 150cm	39" 99cm	2" 5cm
DMS-100B	51" Center Grab Rail, .065"	16 lbs 7.25kg	57" 145cm	39" 99cm	2" 5cm
D5D049	55" Center Grab Rail, .049"	18 lbs 8kg	59" 150cm	39" 99cm	2" 5cm
DMS-100S	60" Center Grab Rail, .065"	18 lbs 8kg	59" 150cm	39" 99cm	2" 5cm

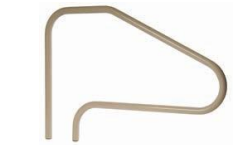

DMS-101

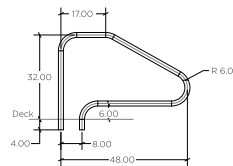

DMS-101

Part No.	Description	Shipping			
		Weight	Length	Width	Height
DMS-101A	48" Center Grab Rail, .049	16 lbs 7kg	59" 150cm	39" 99cm	2" 5cm
DMS-101B	48" Center Grab Rail, .065	16 lbs 7kg	59" 150cm	39" 99cm	2" 5cm

Deck Top Mount

Part No.	Description	Shipping			
		Weight	Length	Width	Height
D4BD049-FL	48" Center Grab Rail, .049 w/flanges and escutcheons	17 lbs 8kg	53" 135cm	39" 99cm	6" 15cm

May be available in Powder-Coated or SealedSteel® finishes. Please reach out to customer-care@srsmith.com to confirm the color and finish availability.

Deck-Mounted Hand & Stair Rails



DMS-102

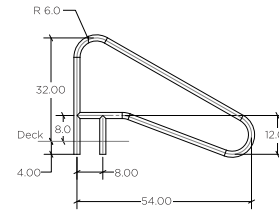

- Tubing: 1.90" OD
- Wall Thickness*: .049" or .065"
- Stainless Steel: 304 or 316L Marine Grade** (add -MG to part number)
- Bends: 6" Radius
- Recommended Anchors: AS-100P or AS-100B (order separately)
- Recommended Escutcheon: EP-100F (order separately)
- Sold as a single rail

* Minimum rail thickness is .065 for Commercial
 ** Minimum requirement for salt pools is 316L Marine Grade

DMS-102

Part No.	Description	Shipping			
		Weight	Length	Width	Height
DMS-102A	54" Center Grab Rail, .049"	19 lbs 9kg	59" 150cm	39" 99cm	2" 5cm
DMS-102B	54" Center Grab Rail, .065"	19 lbs 9kg	59" 150cm	39" 99cm	2" 5cm
DMS-102P	54" Center Grab Rail, .049" w/welded mounting plate	19 lbs 9kg	59" 150cm	39" 99cm	2" 5cm

Deck Top Mount

Part No.	Description	Shipping			
		Weight	Length	Width	Height
D4BD049-FL	49" 4-Bend Stair Rail, .049" w/flanges and escutcheons	27 lbs 12kg	61" 155cm	38" 97cm	7" 18cm



DMS-103

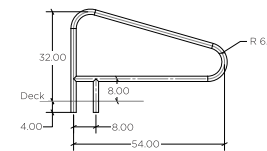

DMS-103

Part No.	Description	Shipping			
		Weight	Length	Width	Height
DMS-103A	54" Center Grab Rail, .049"	14 lbs – 18 lbs 6 – 8kg	59" 150cm	39" 99cm	2" 5cm
DMS-103B	54" Center Grab Rail, .065"	14 lbs – 18 lbs 6 – 8kg	59" 150cm	39" 99cm	2" 5cm

Deck Top Mount

Part No.	Description	Shipping			
		Weight	Length	Width	Height
D3D50049-FL	50" 3-Bend Stair Rail, .049" w/flanges and escutcheons	27 lbs 12kg	61" 155cm	38" 97cm	7" 18cm

May be available in Powder-Coated or SealedSteel® finishes. Please reach out to customer-care@srsmith.com to confirm the color and finish availability.



Deck Mounted Stair Rails

- Tubing: 1.90" OD
- Wall Thickness: .049"
- Stainless Steel: 304 or 316L Marine Grade* (add -MG to part number)
- Bends: 6" Radius
- Recommended anchors: AS-100B (order separately)
- Recommended escutcheon: EP-100F (order separately)
- Sold as pairs

* Minimum requirement for salt pools is 316L Marine Grade

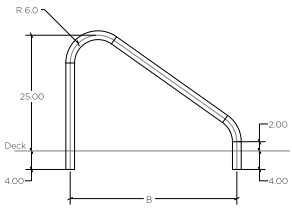

Part No.	Description	Shipping			
		Weight	Length	Width	Height
50-901	30" Side Stair Rail	18 lbs 8kg	40" 102cm	32.5" 82cm	4" 10cm
50-770	32" Side Stair Rail	18 lbs 8kg	40" 102cm	32" 81cm	4" 10cm
50-902	36" Side Stair Rail	15 lbs 7kg	40" 102cm	62.5" 159cm	4" 10cm
50-766	40" Side Stair Rail	18 lbs 8kg	40" 102cm	32" 81cm	4" 10cm
50-903	42" Side Stair Rail	18 lbs 8kg	59" 150cm	39" 99cm	2" 5cm



P-Rails

- Tubing: 1.625" OD
- Wall Thickness: .049"
- Stainless Steel: 304 or 316L Marine Grade* (add -MG to part number)
- Bends: 6" Radius
- Recommended anchor: PR3-101
- Recommended escutcheon: EP-103 (order separately)

* Minimum requirement for salt pools is 316L Marine Grade

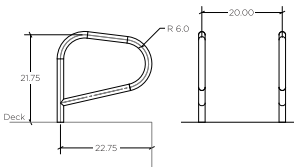

Part No.	Description	Shipping			
		Weight	Length	Width	Height
PR3-100A	Rail set w/Anchor Assembly	16 lbs 7kg	32" 81cm	22" 56cm	4" 10cm
PR3-100B	Rail set only	13 lbs 6kg	32" 81cm	22" 56cm	4" 10cm
PR3-101	Anchor Assembly only	3 lbs 1kg	32" 81cm	22" 56cm	4" 10cm

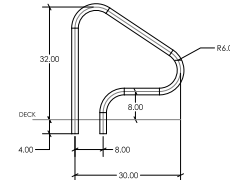

Figure 4

- 600-grit polished finish
- Stainless Steel: 304 or 316L Marine Grade* (add -MG to part number)
- Options: Powder-coating and SealedSteel Salt Friendly available
- Sold as pairs, unless otherwise noted
- Tubing: 1.90" OD
- Wall Thickness: .049", .065"
- Bends: 6" Radius
- Recommended Anchors: AS-100B-SS
- Recommended Escutcheons: EP-100F (order separately)

* Minimum requirement for salt pools is 316L Marine Grade

Residential 30-inch Setback



Residential 26-inch Setback

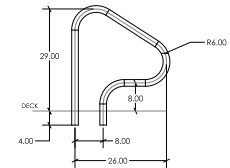

Part No.	Description	Shipping			
		Weight	Length	Width	Height
F4H-100	30" Figure 4, .065" wall, pair 1.90" OD	24 lbs 11kg	39" 99cm	32" 81cm	4" 10cm
F4H-101	30" Figure 4, .049" wall, pair 1.90" OD	19 lbs 9kg	39" 99cm	32" 81cm	4" 10cm
F4H-102	26" Figure 4, .049" wall, pair 1.90" OD	18 lbs 8kg	39" 99cm	32" 81cm	4" 10cm
F4H-102S	26" Figure 4, .049" wall, single 1.90" OD	12 lbs 5kg	39" 99cm	32" 81cm	4" 10cm

Deck Top Mount

Part No.	Description	Shipping			
		Weight	Length	Width	Height
G3D049-FL-SINGLE	28" Figure 4 Rail, .049" w/flanges and escutcheons	13 lbs 6kg	36" 91cm	31" 78cm	6" 15cm
G3D049-FL	28" Figure 4 Rail, .049" w/flanges and escutcheons	18 lbs 8kg	37" 94cm	32" 81cm	5" 13cm
G3D065S-12EXT	28" Figure 4 Rail, .049" w/ 12" extensions on both legs	16 lbs 7kg	53" 135cm	38" 97cm	3" 8cm
G3DE049	26" Figure 4 Rail, Pair, .049" w/flanges and escutcheons	18 lbs 8kg	37" 94cm	32" 81cm	5" 13cm

Economy

Part No.	Description	Shipping			
		Weight	Length	Width	Height
G3DE049-FL-SINGLE	26" Figure 4 Rail, .049" w/flanges and escutcheons	17 lbs 8kg	36" 91cm	35" 89cm	7" 18cm
G3DE049	26" Figure 4 Rail, Pair, .049" w/flanges and escutcheons	18 lbs 8kg	37" 94cm	32" 81cm	5" 13cm
G3DE049-SINGLE	26" Figure 4 Rail, .049" w/flanges and escutcheons	12 lbs 8kg	38" 97cm	33" 84cm	3" 8cm

May be available in Powder-Coated or SealedSteel finishes. Please reach out to customer-care@srsmith.com to confirm the color and finish availability.

May be available in Powder-Coated or SealedSteel finishes. Please reach out to customer-care@srsmith.com to confirm the color and finish availability.

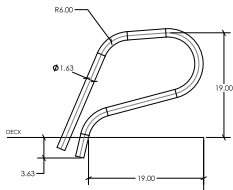
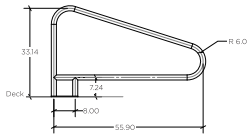
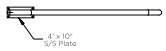
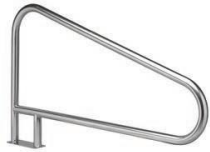
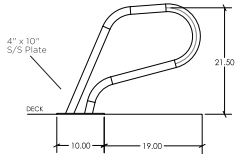

Spa Rail

- Tubing: 1.625" OD
- Wall Thickness: .049"
- Stainless Steel: 304 or 316L Marine Grade* (add -MG to part number)
- Bends: 6" Radius
- No anchor required. Includes a 4" by 10" stainless steel plate drilled for 3/8" bolts (not included)

* Minimum requirement for salt pools is 316L Marine Grade

Part No.	Description	Shipping			
		Weight	Length	Width	Height
SR-100	Single Spa Rail - no hardware	8 lbs 4kg	32" 81cm	22" 56cm	4" 10cm
SPA 1900	20" Single Spa Rail, .049"	8 lbs 4kg	34" 86cm	30" 76cm	3" 8cm

PR-500

- Tubing: 1.90" OD
- Wall Thickness: .049"
- Stainless Steel: 304
- Bends: 6" Radius
- No anchor required. Legs of the rail are surface welded to a mounting plate that has been drilled for 3/8" bolts (not included)

Part No.	Description	Shipping			
		Weight	Length	Width	Height
PR-500	Deck-Mounted Pool Rail with Flanges	18 lbs 8kg	59" 150cm	39" 99cm	2" 5cm

Residential Ring

- Tubing: 1.625" OD
- Wall Thickness: .049"
- Stainless Steel: 304 or 316L Marine Grade* (add -MG to part number)
- Recommended anchors: 34-306A (included)
- Recommended escutcheons: 8-420 (included)

* Minimum requirement for salt pools is 316L Marine Grade

Part No.	Description	Shipping (2 boxes)			
		Weight	Length	Width	Height
RRH-100	Ring Handrails - Rails Only (Pair)	18 lbs 8kg	32" 81cm	22" 56cm	4" 10cm
RRH-100B	Ring Handrails (pair) with Bronze Anchor with escutcheons (pair)	18 lbs 8kg	32" 81cm	22" 56cm	4" 10cm
			24" 61cm	8" 20cm	5" 13cm

Parts & Accessories

- 34-306A Bronze Anchor, Complete
- 8-415A Gibraltar Wedge Retro Fit Kit

May be available in Powder-Coated or SealedSteel® finishes. Please reach out to customer@srsmith.com to confirm the color and finish availability.

Stair Rails

- Tubing: 1.90" OD
- Wall Thickness: .049" or .065"
- Stainless Steel: 304 or 316L Marine Grade** (add -MG to part number)
- Bends: 6" Radius
- Recommended anchors: AS-100B (order separately)
- Recommended escutcheon: EP-100F (order separately)

* Minimum rail thickness is .065 for Commercial

** Minimum requirement for salt pools is 316L Marine Grade



Two Bend

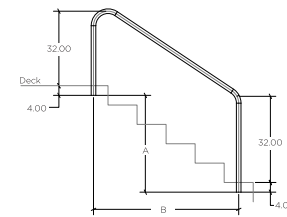

Three Bend

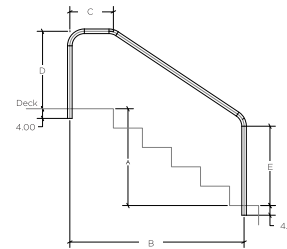

2-Bend

Part No.	Description	A	B	Shipping			
				Weight	Length	Width	Height
2HR-4	4' 2-Bend	26"	4'-0"	10-20 lbs 4-10kg	70" 178cm	37" 94cm	2" 5cm
2HR-5	5' 2-Bend	36"	5'-0"	12-25 lbs 5-11kg	82" 208cm	37" 94cm	2" 5cm
2HR-6	6' 2-Bend	46"	6'-0"	13-32 lbs 6-14kg	97" 246cm	37" 94cm	2" 5cm

• Add -.049 to the part number for .049" wall. Add -.065 to the part number for .065" wall.

• Extended Lengths: Add -1 to the part number for 12" extended length on pool (front) leg. Add -2 to the part number for 12" extended length on both legs. Add -3 to the part number for 12" extended length to deck leg.

3-Bend

Part No.	Description	A	B	C	D	E	Shipping			
							Weight	Length	Width	Height
3HR-4	4' 3-Bend	26"	4'-0"	18"	32"	26"	11-22 lbs 5-10kg	60" 152cm	42" 107cm	2" 5cm
3HR-5	5' 3-Bend	36"	5'-0"	18"	32"	26"	12-24 lbs 5-11kg	72" 183cm	42" 107cm	2" 5cm
3HR-5.5	5'6" 3-Bend	32"	5'-6"	18"	32"	29"	13-21 lbs 6-10kg	78" 198cm	42" 107cm	2" 5cm
3HR-6	6' 3-Bend	46"	6'-0"	18"	32"	26"	13-32 lbs 6-14kg	84" 213cm	42" 107cm	2" 5cm
3HR-6.5	6'6" 3-Bend	32"	6'-6"	35"	34"	29"	16-34 lbs 7-15kg	90" 229cm	42" 107cm	2" 5cm
3HR-7	7' 3-Bend	36"	7'-0"	40"	30"	29"	18-34 lbs 8-15kg	94" 239cm	42" 107cm	2" 5cm
3HR-8	8' 3-Bend	30"	8'-0"	53"	34"	33"	21-39 lbs 10-18kg	105" 267cm	42" 107cm	2" 5cm

• Add -.049 to the part number for .049" wall. Add -.065 to the part number for .065" wall.

• Extended Lengths: Add -1 to the part number for 12" extended length on pool (front) leg. Add -2 to the part number for 12" extended length on both legs. Add -3 to the part number for 12" extended length to deck leg.

May be available in Powder-Coated or SealedSteel® finishes. Please reach out to customer@srsmith.com to confirm the color and finish availability.

Heavy-Duty Stair Rails

- Tubing: 1.50" or 1.90" OD
- Wall Thickness: .065", .109", .120" or .145"
- Stainless Steel: 304
- Bends: 6" Radius
- Recommended anchors: AS-200B for 1.50" and AS-100B for 1.90" (order separately)
- Recommended escutcheons: EP-150 for 1.50" and EP-100F for 1.90" (order separately)

Heavy-Duty Two Bend

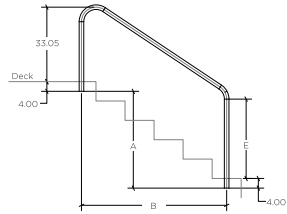

2-Bend Heavy Duty

10145 - 10147:	A=26"	B=48"	E=33.55"
10148 - 10150:	A=34"	B=60"	E=33.85"
10151 - 10153:	A=42"	B=72"	E=34.05"

2-Bend (1.90" OD)

Part No.	Description	Shipping			
		Weight	Length	Width	Height
10145	4 foot 2-bend, .065" wall	14 lbs	70"	37"	2"
10146	4 foot 2-bend, .109" wall	6kg	178cm	94cm	5cm
10147	4 foot 2-bend, .145" wall	23 lbs	70"	37"	2"
		10kg	178cm	94cm	5cm
10148	5 foot 2-bend, .065" wall	30 lbs	70"	37"	2"
		14kg	178cm	94cm	5cm
10149	5 foot 2-bend, .109" wall	16 lbs	82"	37"	2"
		7kg	208cm	94cm	5cm
10150	5 foot 2-bend, .145" wall	25 lbs	82"	37"	2"
		11kg	208cm	94cm	5cm
10151	6 foot 2-bend, .065" wall	33 lbs	82"	37"	2"
		15kg	208cm	94cm	5cm
10152	6 foot 2-bend, .109" wall	17 lbs	97"	37"	2"
		8kg	246cm	94cm	5cm
10153	6 foot 2-bend, .145" wall	28 lbs	97"	37"	2"
		13kg	246cm	94cm	5cm
		36 lbs	97"	37"	2"
		16kg	246cm	94cm	5cm

2-Bend (1.50" OD)

Part No.	Description	Shipping			
		Weight	Length	Width	Height
12047	4 foot 2-bend, .120" wall	17 lbs	70"	37"	2"
		8kg	178cm	94cm	5cm
12048	5 foot 2-bend, .120" wall	18 lbs	82"	37"	2"
		8kg	208cm	94cm	5cm
12049	6 Foot 2-bend, .120" wall	20 lbs	97"	37"	2"
		9kg	246cm	94cm	5cm

3-Bend (1.90" OD)

Part No.	Description	Shipping			
		Weight	Length	Width	Height
10154	4 foot 3-bend, .065" wall	14 lbs	60"	42"	2"
		6kg	152cm	107cm	5cm
10155	4 foot 3-bend, .109" wall	23 lbs	60"	42"	2"
		10kg	152cm	107cm	5cm
10156	4 foot 3-bend, .145" wall	30 lbs	60"	42"	2"
		14kg	152cm	107cm	5cm
10157	5 foot 3-bend, .065" wall	16 lbs	72"	42"	2"
		7kg	183cm	107cm	5cm
10158	5 foot 3-bend, .109" wall	25 lbs	72"	42"	2"
		11kg	183cm	107cm	5cm
10159	5 foot 3-bend, .145" wall	33 lbs	72"	42"	2"
		15kg	183cm	107cm	5cm
10160	6 foot 3-bend, .065" wall	17 lbs	84"	42"	2"
		8kg	213cm	107cm	5cm
10161	6 foot 3-bend, .109" wall	28 lbs	84"	42"	2"
		13kg	213cm	107cm	5cm
10162	6 foot 3-bend, .145" wall	36 lbs	84"	42"	2"
		16kg	213cm	107cm	5cm

3-Bend (1.50" OD)

Part No.	Description	Shipping			
		Weight	Length	Width	Height
12050	4 foot 3-bend, .120" wall	17 lbs	60"	42"	2"
		8kg	152cm	107cm	5cm
12051	5 foot 3-bend, .120" wall	18 lbs	72"	42"	2"
		8kg	183cm	107cm	5cm
12052	6 foot 3-bend, .120" wall	20 lbs	84"	42"	2"
		9kg	213cm	107cm	5cm

Heavy-Duty Three Bend

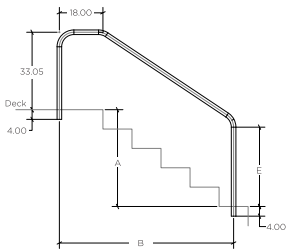

3-Bend Heavy Duty

10154 - 10156:	A=26"	B=48"	E=30.31"
10157 - 10159:	A=34"	B=60"	E=30.19"
10160 - 10162:	A=42"	B=72"	E=30.12"

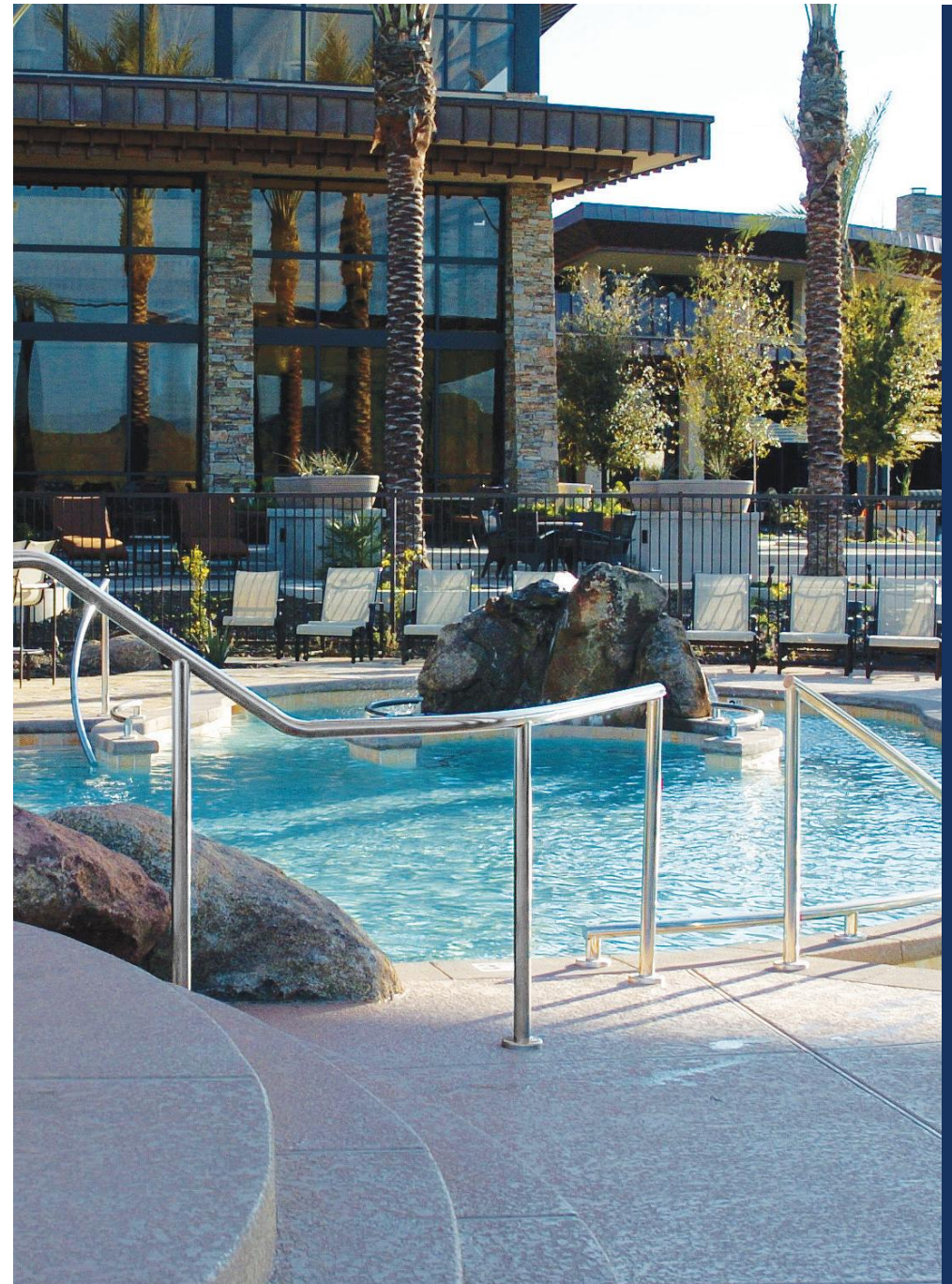

May be available in Powder-Coated or SealedSteel finishes. Please reach out to customer-care@srsmith.com to confirm the color and finish availability.

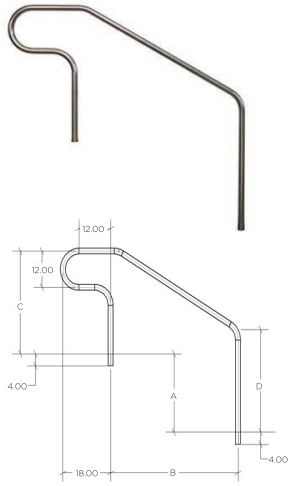

ADA Extended 2-Bend Stair Rails

- Tubing: 1.90" OD
- Wall Thickness: .065"
- Stainless Steel: 304 or 316L Marine Grade* (add -MG to part number)
- Bends: 6" Radius
- Options: Powder-coating and SealedSteel Salt Friendly available
- Recommended anchors: AS-100B (order separately)
- Recommended escutcheon: EP-100F (order separately)
- * Minimum requirement for salt pools is 316L Marine Grade

Part No.	Description	A	B	C	D	Shipping			
						Weight	Length	Width	Height
2HR-4ADA	4' Rail	26"	48"	34"	34"	20 lbs 9kg	72" 183cm	42" 107cm	4" 10cm
2HR-5ADA	5' Rail	36"	60"	34"	34"	22 lbs 10kg	84" 213cm	42" 107cm	4" 10cm
2HR-6ADA	6' Rail	46"	72"	34"	34"	24 lbs 11kg	96" 244cm	42" 107cm	4" 10cm

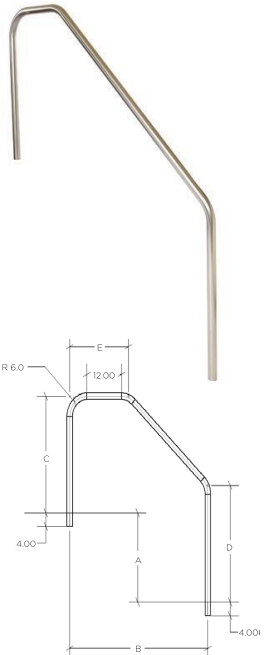

ADA 3-Bend Stair Rails

- Tubing: 1.90" OD
- Wall Thickness: .065"
- Stainless Steel: 304 or 316L Marine Grade* (add -MG to part number)
- Bends: 6" Radius
- Options: Powder-coating and SealedSteel Salt Friendly available
- Recommended anchors: AS-100B (order separately)
- Recommended escutcheon: EP-100F (order separately)
- * Minimum requirement for salt pools is 316L Marine Grade

Part No.	Description	A	B	C	D	E	Shipping			
							Weight	Length	Width	Height
3HR-4ADA	4' Rail	26"	48"	34"	34"	20.38"	20 lbs 10kg	60" 152cm	42" 107cm	4" 10cm
3HR-5ADA	5' Rail	36"	60"	34"	34"	20.32"	22 lbs 10kg	72" 178cm	42" 107cm	4" 10cm
3HR-5.5ADA	5'6" Rail	32"	66"	34"	34"	19.88"	24 lbs 11kg	78" 198cm	42" 107cm	4" 10cm
3HR-6ADA	6' Rail	46"	72"	34"	34"	20.28"	26 lbs 12kg	84" 213cm	42" 107cm	4" 10cm
3HR-6.5ADA	6'6" Rail	32"	78"	34"	34"	35"	28 lbs 13kg	90" 229cm	42" 107cm	4" 10cm
3HR-7ADA	7' Rail	36"	84"	34"	34"	40"	30 lbs 14kg	96" 244cm	42" 107cm	4" 10cm
3HR-8ADA	8' Rail	30"	96"	34"	34"	53"	32 lbs 14kg	108" 274cm	42" 107cm	4" 10cm

Bent Rails with Flanges

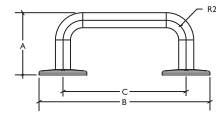

Bent Rails without Flanges

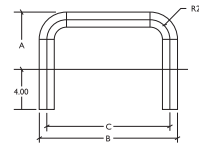

Straight Rails with Flanges

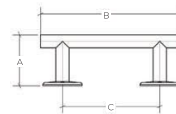

Straight Rails without Flanges

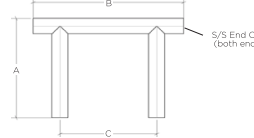

ADA Transfer Rails

- Tubing: 1.50" OD
- Wall Thickness: .120"
- Stainless Steel: 316L Marine Grade*
- Recommended anchor: AS-200B if not flanged (order separately)
- Recommended escutcheon: EP-150 if not flanged (order separately)
- Flanged models include mounting hardware (3/8-16 UNC anchor bolts)
- More transfer and exercise rails on page 102
- Sold as a single rail

* Minimum requirement for salt pools is 316L Marine Grade

Transfer Grab Rail with Flanges - Marine Grade

Part No.	Description	A	B	C	Shipping			
					Weight	Length	Width	Height
EB-12A	12" Rail	5.75"	12"	7.50"	6 lbs 3kg	18" 46cm	6" 15cm	4" 10cm
EB-14A	14" Rail	5.75"	14"	9.50"	6 lbs 3kg	18" 46cm	6" 15cm	4" 10cm
EB-16A	16" Rail	5.75"	16"	11.50"	6 lbs 3kg	18" 46cm	6" 15cm	4" 10cm
EB-18A	18" Rail	5.75"	18"	13.50"	7 lbs 3kg	18" 46cm	6" 15cm	4" 10cm
60-71B	Mounting Hardware				2 lbs 1kg	3" 8cm	3" 8cm	4" 10cm

* No SealedSteel or Powder-Coated on flanged models.

Transfer Grab Rail - Anchors

Part No.	Description	A	B	C	Shipping			
					Weight	Length	Width	Height
EB-12B	12" Rail	5.75"	10"	8.50"	5 lbs 2kg	11" 28cm	11" 28cm	3" 8cm
EB-14B	14" Rail	5.75"	12"	10.50"	5 lbs 2kg	13" 33cm	11" 28cm	3" 8cm
EB-16B	16" Rail	5.75"	14"	12.50"	5 lbs 2kg	15" 38cm	11" 28cm	3" 8cm
EB-18B	18" Rail	5.75"	16"	14.50"	6 lbs 2kg	17" 43cm	11" 28cm	3" 8cm

Straight Transfer Rails with Flanges - Marine Grade

Part No.	Description	A	B	C	Shipping			
					Weight	Length	Width	Height
TR-12A	12" Rail	5.75"	12"	7"	6 lbs 2kg	18" 45cm	16" 40cm	4" 10cm
TR-14A	14" Rail	5.75"	14"	9"	7 lbs 3kg	18" 45cm	16" 40cm	4" 10cm
TR-16A	16" Rail	5.75"	16"	11"	7 lbs 3kg	18" 45cm	16" 40cm	4" 10cm
TR-18A	18" Rail	5.75"	18"	13"	7 lbs 3kg	18" 45cm	16" 40cm	4" 10cm
60-71B	Mounting Hardware				2 lbs 1kg	3" 8cm	3" 8cm	4" 10cm

* No SealedSteel or Powder-Coated on flanged models.

Straight Transfer Rails - Anchors

Part No.	Description	A	B	C	Shipping			
					Weight	Length	Width	Height
TR-12B	12" Rail	9.75"	12"	7"	6 lbs 2kg	13" 33cm	11" 28cm	3" 8cm
TR-14B	14" Rail	9.75"	14"	9"	6 lbs 2kg	15" 38cm	11" 28cm	3" 8cm
TR-16B	16" Rail	9.75"	16"	11"	6 lbs 2kg	17" 43cm	11" 28cm	3" 8cm
TR-18B	18" Rail	9.75"	18"	13"	6 lbs 2kg	19" 48cm	11" 28cm	3" 8cm

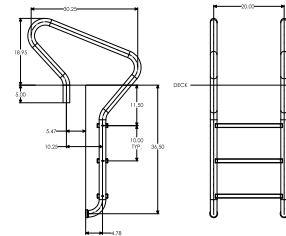

Camelback Ladder

- Tubing: 1.90" OD
- Wall Thickness: .049"
- Stainless Steel: 304
- Treads: LTDF-101 Plastic (Econoline) or LTDF-103 Stainless Steel (Elite)
- Bends: 4" Radius
- Recommended anchors: AS-100B (order separately)
- Recommended escutcheon: EP-100F (order separately)

Econoline	Shipping Weight	Elite	Shipping Weight	Description	Shipping		
					Length	Width	Height
CBL-103E	27 lbs 12kg	CBL-103S	32 lbs 14kg	3-step ladder	59"	39"	2"
					150cm	99cm	5cm

Frames extend 6 1/2" from the pool wall. Frame is secured to the pool deck with two anchor sockets, 5 1/4" from the pool wall on 20" centers (Elite model) or 19" centers (Econoline model). The lower end of the frame is bent to meet the pool wall and fitted with two white rubber bumpers (WRB-100A)

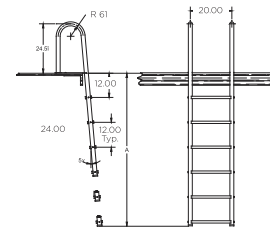

Dock Ladder

- Tubing: 1.90" OD
- Wall Thickness: .065"
- Stainless Steel: 304 or 316L Marine Grade* (add - MG to part number)
- Treads: LTDF-103 Stainless Steel
- Bends: 4" Radius
- * Minimum requirement for salt pools is 316L Marine Grade

No.	Description	Shipping			Part
		Weight	Length	Width	Height
LLS-4	4-Step Ladder	60 lbs 27kg	82" 208cm	28" 71cm	2" 5cm
LLS-5	5-Step Ladder	65 lbs 29kg	90" 229cm	28" 71cm	2" 5cm
LLS-6	6-Step Ladder	70 lbs 32kg	98" 249cm	28" 71cm	2" 5cm

The keyhole tie down plate (1/4" x 2" x 15") allows the ladder to be easily locked and unlocked from the deck. Mounting bolts are not included but require 3/8" x 4" long bolt.

May be available in Powder-Coated or SealedSteel finishes. Please reach out to customer@srsmith.com to confirm the color and finish availability.



Dade County Ladder

- Tubing: 1.90" OD
- Wall Thickness: .049"
- Stainless Steel: 304 or 316L Marine Grade* (add -MG to part number)
- Treads: LTDF-101 Plastic (Econoline) or LTDF-103 Stainless Steel (Elite)
- Bends: 4" Radius
- Recommended anchors: AS-100B (order separately)
- Recommended escutcheon: EP-100F (order separately)

* Minimum requirement for salt pools is 316L Marine Grade

Econoline	Shipping		Description	Shipping				
	Weight	Elite		Weight	Length	Width	Height	
50-792E-24	32 lbs 14kg		50-792S-24	34 lbs 15kg	24" 3-Step Rollout w/ Crossbrace	78" 198cm	42" 107cm	2" 5cm
50-792E-30	34 lbs 15kg		50-792S-30	36 lbs 16kg	30" 3-Step Rollout w/ Crossbrace	78" 198cm	42" 107cm	2" 5cm
50-792E-32-MG	34 lbs 15kg		50-792S-30	36 lbs 16kg	32" 3-Step Rollout w/ Crossbrace	78" 198cm	42" 107cm	2" 5cm
50-792E-36	40 lbs 18kg		50-792S-36	42 lbs 20kg	36" 3-Step Rollout w/ Crossbrace	78" 198cm	42" 107cm	2" 5cm
50-795E	35 lbs 16kg		50-795S	37 lbs 17kg	22" 3-Step w/ Crossbrace	71" 180cm	29" 74cm	2" 5cm

Frames extend 4 1/2" from the pool wall. Frame is secured to the pool deck with two anchor sockets on 20" centers (Elite model) or 19" centers (Econoline model). The lower end of the frame is bent to meet the pool wall and fitted with two white rubber bumpers (WRB-100A).



Easy-Out Therapeutic Ladder

- Tubing: 1.90" OD
- Wall Thickness: .065"
- Stainless Steel: 304 or 316L Marine Grade* (add -MG to part number)
- Treads: LTDF-105 Stainless Steel
- Bends: 4" Radius
- Recommended anchor: AS-100B (order separately)
- Recommended escutcheon: EP-100At905u yuu

* Minimum requirement for salt pools is 316L Marine Grade

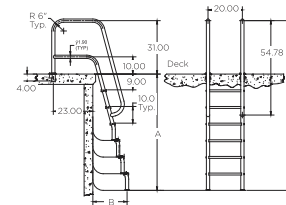

Part No.	Description	Shipping			
		Weight	Length	Width	Height
TL-3B	3-Step Ladder	35 lbs 16kg	77" 196cm	41" 104cm	4" 10cm
TL-4C	4-Step Ladder	41 lbs 18kg	82" 208cm	41" 104cm	4" 10cm
TL-5D	5-Step Ladder	47 lbs 21kg	92" 234cm	41" 104cm	4" 10cm
TL-6E	6-Step Ladder	55 lbs 25kg	105" 267cm	41" 104cm	4" 10cm

Frame is secured to the pool deck with two anchor sockets on 20" centers. The lower end of the frame rests on the pool floor and is fitted with two white rubber bumpers (WRB-100A).



Vinyl Liner Economy Ladder

- Tubing: 1.90" OD
- Wall Thickness: .049"
- Stainless Steel: 304 or 316L Marine Grade* (add -MG to part number)
- Treads: LTDF-101 Plastic (Econoline) or LTDF-103 Stainless Steel (Elite)
- Bends: 4" Radius
- Recommended anchors: AS-100B (order separately)
- Recommended escutcheon: EP-100F (order separately)

* Minimum requirement for salt pools is 316L Marine Grade

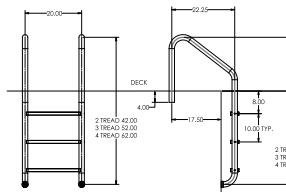

Econoline	Shipping		Description	Shipping				
	Weight	Elite		Weight	Length	Width	Height	
VLLS-102E	21 lbs 10kg		VLLS-102S	23 lbs 10kg	2-step ladder	61" 155cm	29" 74cm	2" 5cm
VLLS-103E	23 lbs 10kg		VLLS-103S	25 lbs 11kg	3-step ladder	61" 155cm	29" 74cm	2" 5cm
VLLS-104E	24 lbs 11kg		VLLS-104S	27 lbs 12kg	4-step ladder	66" 168cm	29" 74cm	2" 5cm

Frames extend 5 1/2" from the pool wall. Frame is secured to the pool deck with two anchor sockets on 20" centers (Elite model) or 19" centers (Econoline model). The lower end of the frame is bent to meet the pool wall and fitted with two white rubber bumpers (WRB-100A).

May be available in Powder-Coated or SealedSteel finishes. Please reach out to customer@srsmith.com to confirm the color and finish availability.

May be available in Powder-Coated or SealedSteel finishes. Please reach out to customer@srsmith.com to confirm the color and finish availability.



On-Ground Ladder

- Tubing: 1.90" OD
- Wall Thickness: .049"
- Stainless Steel: 304 or 316L Marine Grade* (add -MG to part number)
- Treads: LTDF-101 Plastic (Econoline) or LTDF-103 Stainless Steel (Elite)
- Bends: 4" Radius

* Minimum requirement for salt pools is 316L Marine Grade

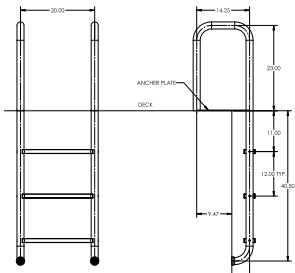

Econoline	Elite	Description	Shipping			
			Weight	Length	Width	Height
OGL-3E-100	OGL-3S-100	3-step ladder (66" total height)	27 lbs 12kg	69" 175cm	16" 41cm	2" 5cm
OGL-3E-101	OGL-3S-101	3-step ladder (61" total height)	27 lbs 12kg	69" 175cm	16" 41cm	2" 5cm

Mounting bolts are not included but require 3/8" x 4" long bolt. Frames extend 5 1/2" from the pool wall. Frame is secured to the pool deck with two anchor sockets on 20" centers (Elite model) or 19" centers (Econoline model). The lower end of the frame is bent to meet the pool wall and fitted with two white rubber bumpers (WRB-100A).

Parallel-Look Ladder

- Tubing: 1.90" OD
- Wall Thickness: .049"
- Stainless Steel: 304 or 316L Marine Grade* (add -MG to part number)
- Treads: LTDF-101 Plastic (Econoline) or LTDF-103 Stainless Steel (Elite)
- Bends: 4" Radius
- Options: Powder-coating and SealedSteel Salt Friendly (rails only)
- Recommended anchors: AS-100B (order separately)
- Recommended escutcheon: EP-100F (order separately)

* Minimum requirement for salt pools is 316L Marine Grade

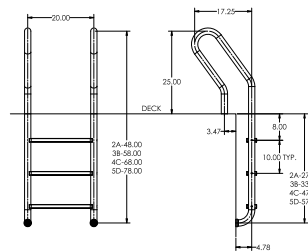

Econoline	Shipping Weight	Elite	Shipping Weight	Description	Shipping		
					Length	Width	Height
PLL-12E-2A	22 lbs 10kg	PLL-12S-2A	22 lbs 10kg	2-step	60" 152cm	28" 71cm	2" 5cm
PLL-12E-3B	24 lbs 11kg	PLL-12S-3B	24 lbs 11kg	3-step	65" 165cm	28" 71cm	2" 5cm
PLL-12E-4C	28 lbs 13kg	PLL-12S-4C	28 lbs 13kg	4-step	82" 208cm	28" 71cm	2" 5cm
PLL-12E-5D	31 lbs 15kg	PLL-12S-5D	31 lbs 15kg	5-step	90" 229cm	28" 71cm	2" 5cm

Frames extend 5 1/2" from the pool wall. Frame is secured to the pool deck with two anchor sockets, 3 1/2" from the pool wall on 20" centers (Elite model) or 19" centers (Econoline model). The lower end of the frame is bent to meet the pool wall and fitted with two white rubber bumpers (WRB-100A).



Residential Ladder

- Tubing: 1.90" OD
- Wall Thickness: .049"
- Stainless Steel: 304 or 316L Marine Grade* (add -MG to part number)
- Treads: LTDF-101 Plastic (Econoline) or LTDF-103 Stainless Steel (Elite)
- Bends: 4" Radius
- Options: Powder-coating and SealedSteel Salt Friendly (rails only)
- Recommended anchors: AS-100B (order separately)
- Recommended escutcheon: EP-100F (order separately)

* Minimum requirement for salt pools is 316L Marine Grade

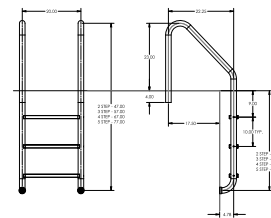

Econoline	Shipping Weight	Elite	Shipping Weight	Description	Shipping		
					Length	Width	Height
RLF-24E-2A	21 lbs 10kg	RLF-24S-2A	22 lbs 10kg	2-step ladder	60" 152cm	28" 71cm	2" 5cm
RLF-24E-3B	24 lbs 11kg	RLF-24S-3B	25 lbs 11kg	3-step ladder	65" 165cm	28" 71cm	2" 5cm
RLF-24E-4C	29 lbs 13kg	RLF-24S-4C	30 lbs 14kg	4-step ladder	82" 208cm	28" 71cm	2" 5cm
RLF-24E-5D	32 lbs 14kg	RLF-24S-5D	33 lbs 15kg	5-step ladder	90" 229cm	28" 71cm	2" 5cm

Frames extend 5 1/2" from the pool wall. Frame is secured to the pool deck with two anchor sockets on 20" centers (Elite model) or 19" centers (Econoline model). The lower end of the frame is bent to meet the pool wall and fitted with two white rubber bumpers (WRB-100A).



Snap-Lok Ladder

- Tubing: 1.90" OD
- Wall Thickness: .049"
- Stainless Steel: 304 or 316L Marine Grade* (add -MG to part number)
- Treads: LTDF-101 Plastic (Econoline) or LTDF-103 Stainless Steel (Elite)
- Bends: 4" Radius
- Recommended anchors: AS-100B (order separately)
- Recommended escutcheon: EP-100F (order separately)
- Stainless steel hinge brackets (60-713) are bolted to ladder frames with stainless steel bolts and acorn nuts.

* Minimum requirement for salt pools is 316L Marine Grade

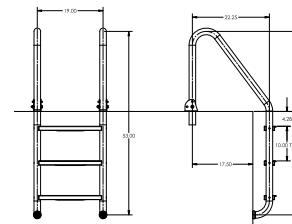

Econoline	Shipping Weight	Elite	Shipping Weight	Description	Shipping		
					Length	Width	Height
SLF-24E-3B	24 lbs 11kg	SLF-24S-3B	25 lbs 11kg	3-step ladder	61" 155cm	29" 74cm	2" 5cm

Frames extend 5 1/2" from the pool wall. Frame is secured to the pool deck with two anchor sockets on 20" centers (Elite model) or 19" centers (Econoline model). The lower end of the frame is bent to meet the pool wall and fitted with two white rubber bumpers (WRB-100A). We do not recommend powder-coating or vinyl coating.

May be available in Powder-Coated or SealedSteel finishes. Please reach out to customer@srsmith.com to confirm the color and finish availability.

May be available in Powder-Coated or SealedSteel finishes. Please reach out to customer@srsmith.com to confirm the color and finish availability.

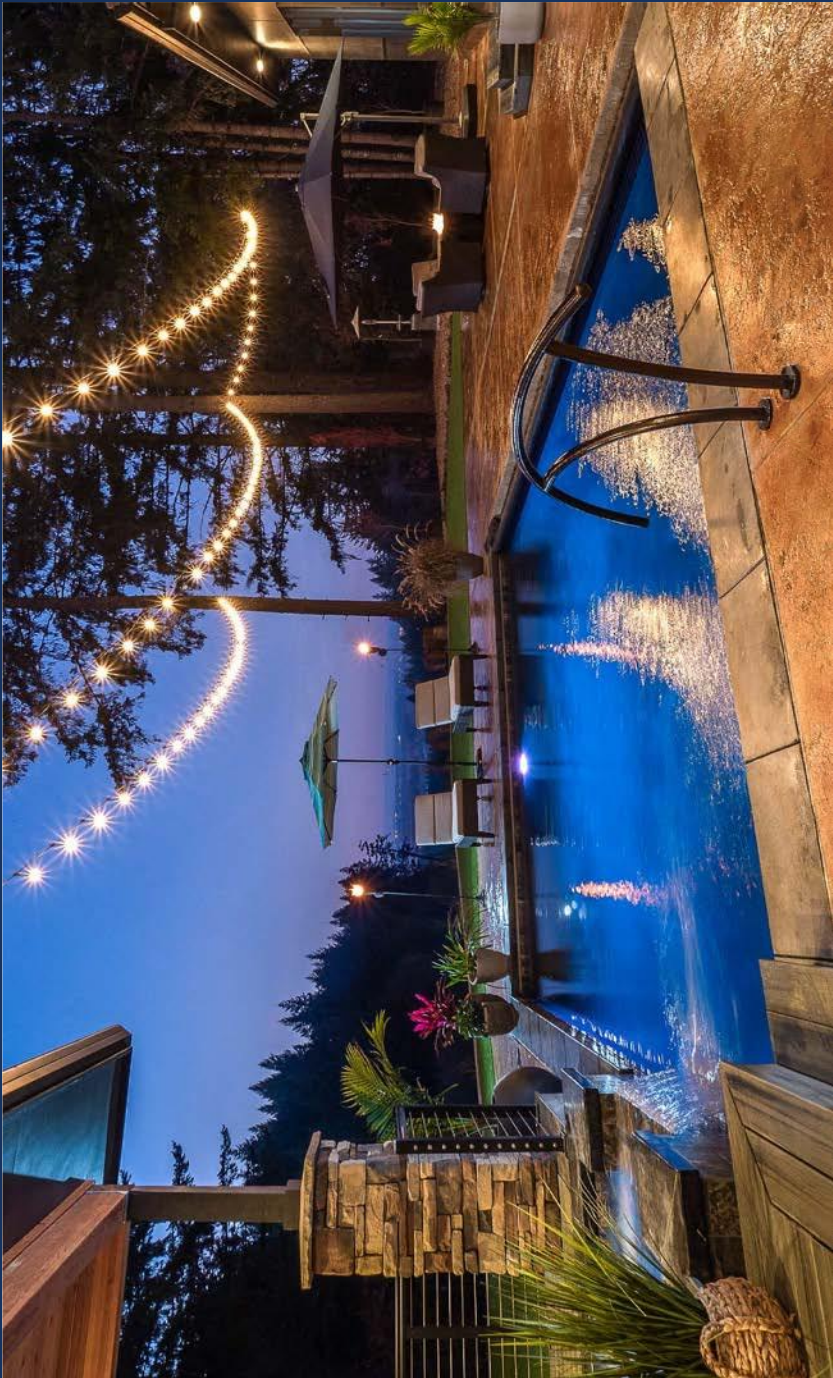

Pool Better™

SRSmith®

800.824.4387
srsmith.com

No part of this may be copied or reproduced without the expressed written consent of S.R. Smith, LLC
©Copyright 2021 S.R. Smith, LLC. All rights reserved. | M-E-BRO-50
TOM 0321