

PREMIER

WOOD-BURNING FIREPLACES

HEAT & GLO®



TRADITION
YOU CAN FEEL



WOOD FIREPLACES

Big statements, bold flames and beautiful finishes. Heat & Glo wood-burning fireplaces enhance the tradition of fire. Whether at a crackle or a blaze, relax and unwind with upgraded safety, style and performance.

RUTHERFORD **A**

Bold performance and a custom-built masonry appearance. The Rutherford anchors a space with distinct finishing details and vivid flames. Highlighted within a massive viewing area. Available in three sizes.

NORTHSTAR **B**

The EPA-certified Northstar exceeds the strictest environmental burn standards in the U.S. Enjoy roaring fires in areas where conventional wood-burning fireplaces are banned. Powerful flames and high-efficiency performance are at home in any environment.



COVER: RUTHERFORD

LEFT: RUTHERFORD 50 shown with herringbone refractory and mesh screen



EXCLAIM C

Ignite warmth and ambiance in your favorite room. The Exclaim makes a statement with a textured brick interior, large viewing area and comforting radiant heat. Choose square or contoured doors to complete your look. Available in three sizes.

ENERGY MASTER D

Relax with big flames and generous warmth. The Energy Master provides greater radiant heat, and custom finishing options. Complete your look with multiple front and gas log choices, or a cast mantel. Available in two sizes.

ROYAL HEARTH E

It's easier to relax with the Royal Hearth in the room. An easy-to-operate damper, helpful ash lip and invisible smoke shield add convenience to tradition. Available in two sizes.



DOOR OPTIONS



BI-FOLD GLASS DOORS

Available in black or bronze for Rutherford models only.



GRAND VISTA MESH DOORS

Available in black or bronze for Exclaim and Energy Master models only.



GASKETED GLASS DOORS

Available in black for Energy Master models only.

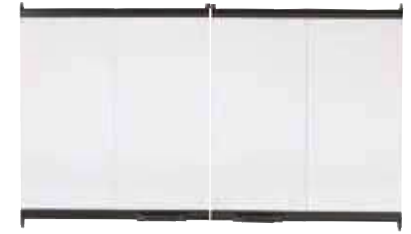

BI-FOLD GLASS DOORS

Available in black or stainless steel trim. Not available for Rutherford models.

DOOR FINISHES

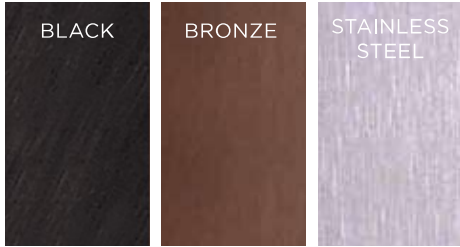

RUTHERFORD ANDIRONS

Standard cast iron andirons help you build bigger, bolder fires and add style to your firebox.



INTERIOR OPTIONS

Rutherford and Exclaim models come with your choice of traditional or herringbone refractories.



RUTHERFORD TRADITIONAL



RUTHERFORD HERRINGBONE



EXCLAIM TRADITIONAL



EXCLAIM HERRINGBONE

SPECIFICATIONS

RUTHERFORD SPECIFICATIONS

MODEL	FRONT WIDTH		BACK WIDTH		HEIGHT		DEPTH		FIREBOX OPENING
	UNIT	FRAMING	UNIT	FRAMING ¹	UNIT	FRAMING	UNIT	FRAMING	
RUTHERFORD-36	46-7/8 [1191]	47-7/8 [1216]	31-1/8 [790]	47-7/8 [1216]	74-1/8 [1883]	74-1/4 [1886]	27-1/2 [699]	28-1/2 [724]	36 x 38 [914 x 965]
RUTHERFORD-42	52-7/8 [1343]	53-7/8 [1368]	37-1/8 [943]	53-7/8 [1368]	74-1/8 [1883]	74-1/2 [1892]	27-1/2 [699]	28-1/2 [724]	42 x 38 [1067 x 965]
RUTHERFORD-50	60-7/8 [1546]	61-7/8 [1572]	45-1/8 [1146]	61-7/8 [1572]	74-1/8 [1883]	74-1/2 [1892]	27-1/2 [699]	28-1/2 [724]	50 x 38 [1270 x 965]

Drawings below represent the Rutherford 36, 42, & 50 combined.

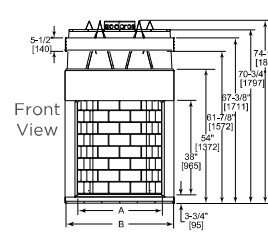
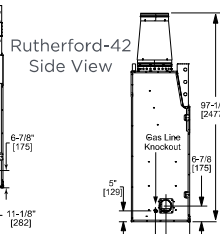
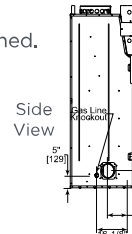
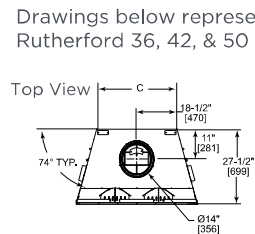

MODEL	A	B	C
RUTHERFORD-36	36 [914]	46-7/8 [1191]	31-1/8 [790]
RUTHERFORD-42	42 [1067]	52-7/8 [1343]	37-1/8 [943]
RUTHERFORD-50	50 [1270]	60-7/8 [1546]	45-1/8 [1146]

NORTHSTAR SPECIFICATIONS

MODEL	FRONT WIDTH		BACK WIDTH		FRONT HEIGHT		REAR HEIGHT		DEPTH		FIREBOX OPENING
	Unit	Framing	Unit	Framing ¹	Unit	Framing	Unit	Framing	Unit	Framing	
Northstar-C*	40 [1016]	42-1/2 [1080]	40 [1016]	42-1/2 [1080]	40-1/2 [1029]	56-3/4 [1441]	40-1/2 [1029]	56-3/4 [1442]	23-1/2 [597]	24** [610]**	37 x 31-1/8 [940 x 791]

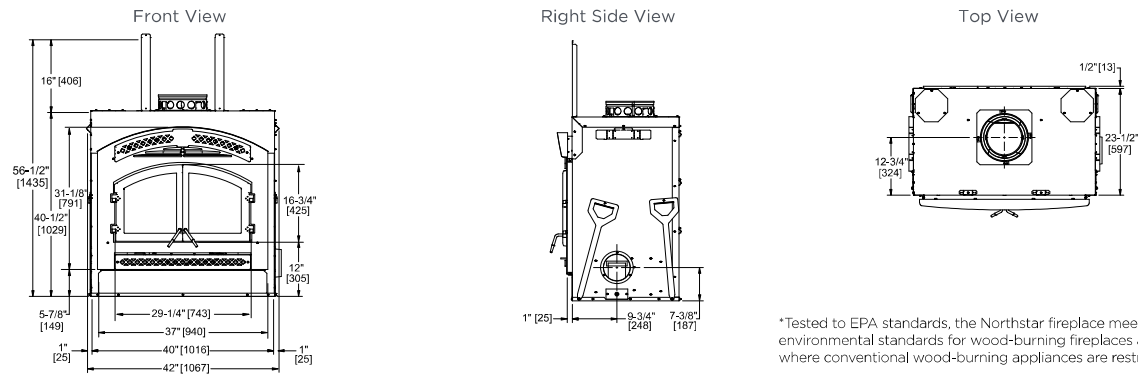

*Tested to EPA standards, the Northstar fireplace meets the strictest environmental standards for wood-burning fireplaces and can be used in areas where conventional wood-burning appliances are restricted or banned.
 **If interior of chase will be drywalled, add the thickness to this measurement.

ROYAL HEARTH SPECIFICATIONS

MODEL	FRONT WIDTH		BACK WIDTH		HEIGHT		DEPTH		FIREBOX OPENING
	UNIT	FRAMING	UNIT	FRAMING ¹	UNIT	FRAMING	UNIT	FRAMING	
RH-36	41 [1041]	42 [1067]	23-3/4 [603]	42 [1067]	39-1/2 [1003]	39-3/4 [1010]	21-3/8 [543]	21-1/2 [546]	36 x 21 [914 x 533]
RH-42	47 [1194]	48 [1219]	29-3/4 [756]	48 [1219]	39-1/2 [1003]	39-3/4 [1010]	21-3/8 [543]	21-1/2 [546]	42 x 21 [1067 x 533]

Drawings below represent the RH-36 and RH-42 combined.

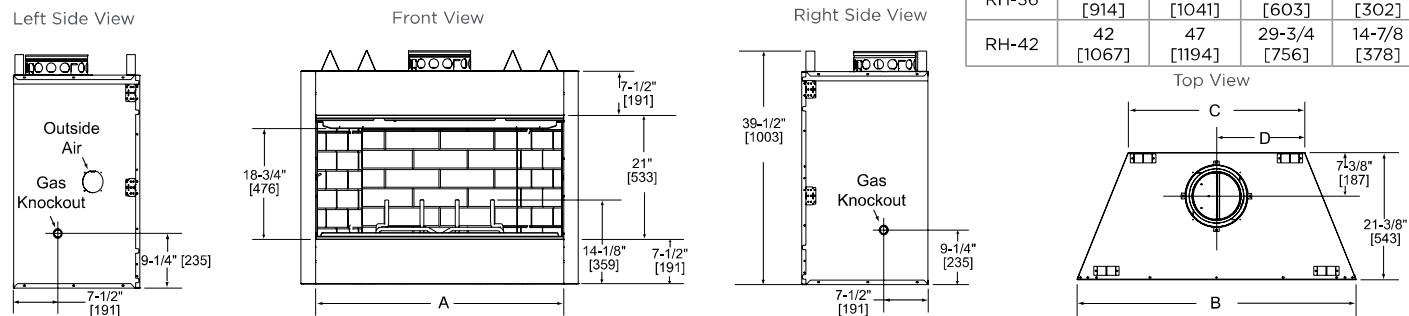

MODEL	A	B	C	D
RH-36	36 [914]	41 [1041]	23-3/4 [603]	11-7/8 [302]
RH-42	42 [1067]	47 [1194]	29-3/4 [756]	14-7/8 [378]

Dimensions for all fireplaces are in inches and millimeters. Reference dimensions only. We recommend measuring individual units at installation. Assumes the use of 1/2" [13] Sheetrock. NOTE: Non-combustible material is allowed over this dimension. Make sure you do NOT cover the decorative door opening.

Refer to installation manual for detailed specifications on installing this product. Heat & Glo reserves the right to update units periodically. Actual product appearance, including flame, may differ from product images.

¹ When using outside air, refer to install manual for framing dimensions.

EXCLAIM SPECIFICATIONS

MODEL	FRONT WIDTH		BACK WIDTH		FRONT HEIGHT		REAR HEIGHT		DEPTH		FIREBOX OPENING
	UNIT	FRAMING	UNIT	FRAMING ¹	UNIT	FRAMING ROUGH OPENING	UNIT	FRAMING	UNIT	FRAMING	
EXCLAIM-36	44-1/2 [1130]	45-1/2 [1156]	28-5/8 [727]	45-1/2 [1156]	49-5/8 [1260]	59-3/4 [1518]	59-1/4 [1505]	59-3/4 [1518]	27-1/2 [699]	28 [711]	36 x 28-1/2 [914 x 724]
EXCLAIM-42	50-1/2 [1283]	51-1/2 [1308]	34-1/2 [876]	51-1/2 [1308]	49-5/8 [1260]	59-3/4 [1518]	59-1/4 [1505]	59-3/4 [1518]	27-1/2 [699]	28-1/2 [724]	42 x 28-1/2 [1067 x 724]
EXCLAIM-50	60-5/8 [1540]	61-5/8 [1565]	41-5/8 [1057]	61-5/8 [1565]	60-1/4 [1530]	71 [1803]	70-1/2 [1791]	71 [1803]	29-1/2 [749]	30-1/2 [772]	50 x 33 [1270 x 838]

Drawings below represent the Exclaim 36, 42, & 50 combined.

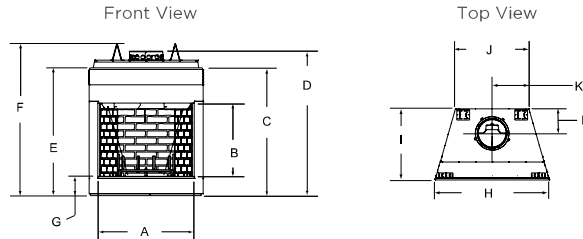

MODEL	A	B	C	D	E	F	G	H	I	J	K	L
EXCLAIM 36	36 [914]	28-1/2 [724]	49-1/8 [1248]	55-1/2 [1410]	49-5/8 [1260]	59-1/4 [1505]	7-5/8 [194]	44-1/2 [1130]	27-1/2 [699]	28-5/8 [727]	14-3/8 [365]	9-1/2 [241]
EXCLAIM 42	42 [1067]	28-1/2 [724]	49-1/8 [1248]	55-1/2 [1410]	49-5/8 [1260]	59-1/4 [1505]	7-5/8 [194]	50-1/2 [1283]	27-1/2 [699]	34-1/2 [876]	17-3/8 [441]	9-1/2 [241]
EXCLAIM 50	50 [1270]	33 [838]	54-3/8 [1381]	68-1/8 [1730]	60-1/4 [1530]	70-1/2 [1791]	8-3/4 [222]	60-5/8 [1540]	29-1/2 [749]	41-5/8 [1057]	20-3/4 [527]	11-5/8 [295]

ENERGY MASTER SPECIFICATIONS

MODEL	FRONT WIDTH		BACK WIDTH		FRONT HEIGHT		REAR HEIGHT		DEPTH		FIREBOX OPENING
	UNIT	FRAMING	UNIT	FRAMING ¹	UNIT	FRAMING	UNIT	FRAMING	UNIT	FRAMING	
EM-415	42 [1067]	43 [1092]	28-1/4 [718]	43 [1092]	41-3/8 [1051]	41-1/2 [1054]	41-3/8 [1051]	41-1/2 [1054]	22-3/4 [578]	23 [584]	36 x 23-3/8 [914 x 594]
EM-485T	48 [1219]	49 [1245]	30-7/8 [784]	49 [1245]	41-3/8 [1051]	41-1/2 [1054]	41-3/8 [1051]	41-1/2 [1054]	22-3/4 [578]	23 [584]	42 x 23-3/8 [1067 x 594]

Energy Master Model EM-415

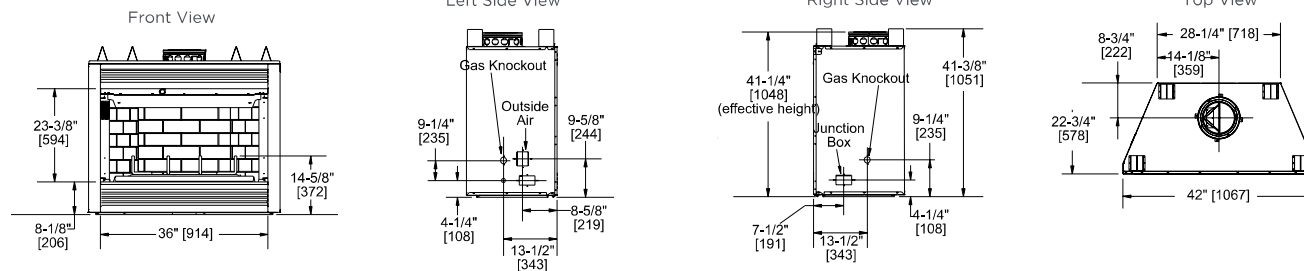

Energy Master Model EM-485T

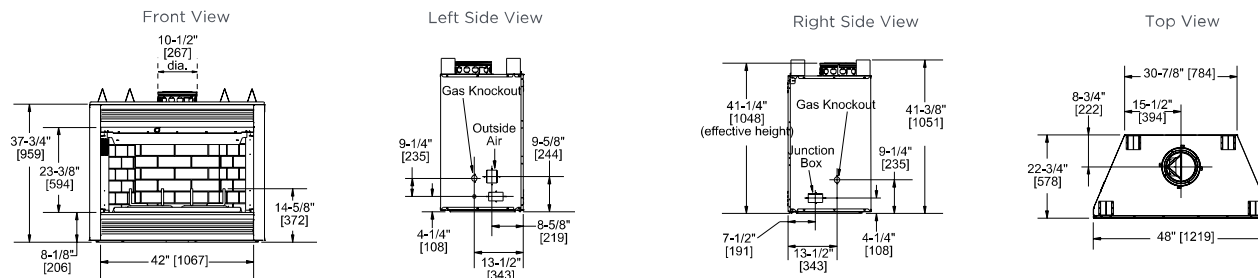

For complete information on this model,
please contact us at:

HEAT&GLO

No one builds a better fire

Web: heatnglo.com
Phone: (888) 427-3973
E-mail: info@heatnglo.com

 facebook.com/HeatandGlo

 twitter.com/HeatandGlo

 youtube.com/HeatandGlo

LIMITED LIFETIME WARRANTY²

The strongest in the industry, Heat & Glo provides a limited lifetime warranty on the most important aspects: firebox and heat exchanger.

² For full warranty details, go to www.heatnglo.com.

Fireplace, stove and insert surfaces get extremely HOT and can cause severe burns if touched. Keep a safe distance away. To learn more visit heatnglo.com/fireplacesafety.



HNG-1029U-0521