

Fire. Art. Passion.

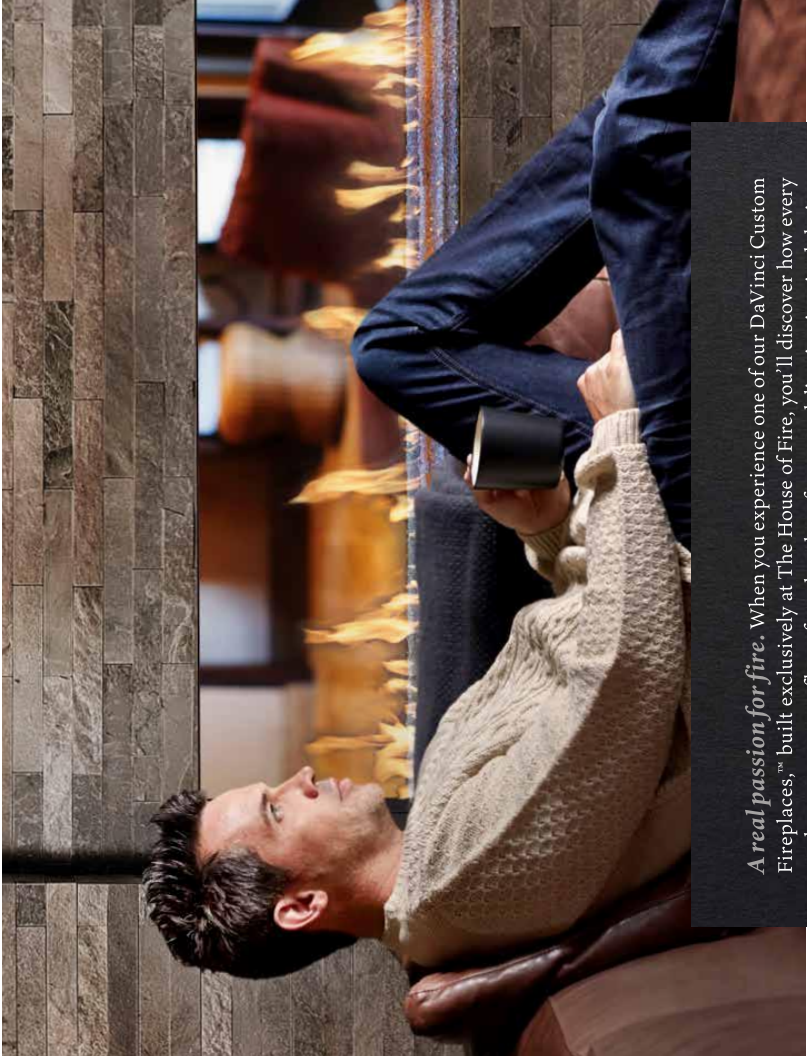

DaVinci Custom Fireplaces™



*A real passion for fire.* When you experience one of our DaVinci Custom Fireplaces,<sup>™</sup> built exclusively at The House of Fire, you'll discover how every product we create reflects four decades of success delivering inspired design, long-lasting quality and the world's most engaging flames.

Learn more at [DaVincifireplace.com](http://DaVincifireplace.com)

“Of the  
original  
phenomena,  
light is the most  
enthralling.”

Leonardo da Vinci

4 THE DAVINCI LINEAR COLLECTION

Eight Configurations • Six Glass Heights • Two to Sixty-Six Foot Lengths in One Foot Increments • Endless Combinations

---

4-9	Overview
10-13	Single-Sided Configuration
14-15	Island Configuration
16-17	Left Corner Configuration
16-17	Right Corner Configuration
18	Bay Configuration
19 & 49	Pier Configuration
20-23	See-Thru Configuration
24-25	“L” Configuration

2.6 THE DAVINCI MAESTRO™ COLLECTION

Four Configurations • Four Glass Heights • Three Widths • Sixteen Combinations

---

26-29	Overview
30-31	Square Single-Sided Configuration
32-33	Square See-Thru Configuration (Not Illustrated in This Catalog)
34	Vertical Single-Sided Configuration
	Vertical See-Thru Configuration

3.5 INNOVATIONS

---

36	Certifications and Modular Construction
37	Safe Touch Glass™
38	Media Selections
39	TouchSmart™
40	Home Automation
41	Zero Clearance To Combustibles
41	Exterior Window Kit
42-43	Fyre-Art™
44	Artisan Trims
45	Liners
45	Post-less Design
45	Heat Exchanger Kit
46-47	Venting

---

48	Built To Be Better
50	Resources



# THE DAVINCI LINEAR COLLECTION

## *The most incredible linear fireplace in the world.*

There are quite a few linear fireplace companies out there, yet none can compare to DaVinci Custom Fireplaces™. These modular, linear fireplaces deliver near-limitless options to fit any design vision for all spaces great and small.

- ↔ THE WORLD'S ONLY MODULAR FIREPLACE: 2, 3, 4 AND 5 FOOT MODULES THAT CAN BE COMBINED UP TO 66 FEET IN LENGTH
- 📏 EIGHT STUNNING LINEAR CONFIGURATIONS (SEE PAGES 6 & 7)
- 📏 SIX DRAMATIC GLASS HEIGHTS
- 🌊 SAFE TOUCH GLASS™ (NO SAFETY SCREENS OR NOISY FANS)
- 🔥 SIGNATURE WALL-TO-WALL CONTINUOUS LINEAR FIRE
- 💡 MULTICOLOR LED UNDERLIGHTING
- 💡 OVERHEAD ACCENT LIGHTING
- 🏠 CUSTOM FIREPLACES DESIGNED AND MANUFACTURED IN 4 TO 6 WEEKS
- 🛡️ ANSI CERTIFIED NON-HEATER RATED DECORATIVE FIREPLACE



SINGLE-SIDED CONFIGURATION: 156 X 30 INCHES; PLATINUM CRUSHED GLASS MEDIA AND BLACK GLASS LINER

QUEENS PLAZA LUXURY APARTMENT PUBLIC SPACE  
SAFE TOUCH™ GLASS WAS A PRIORITY FOR THIS CUSTOMER.  
DAVINCI'S FLEXIBILITY FOR INSTALLATION WAS ABLE TO SOLVE THE  
DIFFICULT VENTING CONFIGURATION THAT THIS PROJECT PRESENTED.

THE DAVINCI LINEAR COLLECTION

## Eight Stunning Modular, Linear Configurations

All of our fireplace configurations, except the Island, feature a post-less design for the appearance of a clean, glass-to-glass edge and unobstructed viewing area.

Our DaVinci experts will work with you and your design-construction team to create a custom configuration that fits your vision, resulting in a stunning fireplace focal point. Your choices are endless - from 2 feet to 66 feet in length.



66-FOOT SINGLE-SIDED DAVINCI INSTALLED AT THE DEAN APARTMENTS, MOUNTAIN VIEW, CA

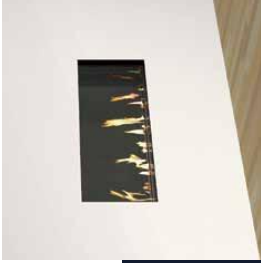

SINGLE-SIDED

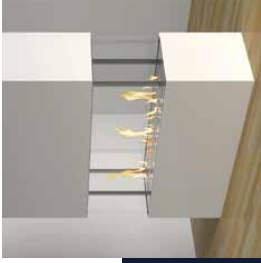

ISLAND



LEFT CORNER



RIGHT CORNER



BAY



PIER



SEETHRU



"L"



SEE-THRU FEATURING THE EXTERIOR WINDOW KIT

## Six Dramatic Glass Heights

For comparative purposes, all glass heights below are shown on 60 inch long Single-Sided DaVinci fireplaces.



12 INCHES



20 INCHES

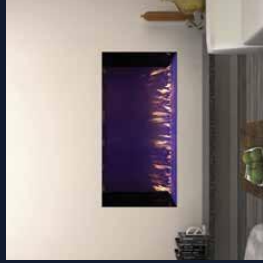

30 INCHES



36 INCHES



48 INCHES



58 INCHES

## Our Equation for Creativity

Eight Linear Configurations + Six Glass Heights  
+ Lengths from 2 to 66 Feet, in 2, 3, 4 and 5 Foot  
Modules = Thousands of Combinations

**We set out to redefine “custom.”** We found that modularity and flexibility would be the answer to so many problems associated with typical custom fireplaces. It is a concept that allows us to continue unlocking imaginative and innovative possibilities for any space where custom is key.

- ✓ EASILY AND EFFICIENTLY TRANSPORT EVEN OUR LARGEST FIREPLACES TO JOB SITES WITHOUT ANY SPECIAL PLANNING - NO CRANES NECESSARY
- ✓ TITAN LOCK SYSTEM™ PERMANENTLY BOLTS MULTIPLE MODULES TOGETHER ON LOCATION
- ✓ THE ABILITY TO CREATE THOUSANDS OF COMBINATIONS





THE DAVINCI LINEAR COLLECTION

### Single-Sided Configuration

Accommodating any living space in a wide range of applications, the Single-Sided DaVinci gives you the best fire presentation compared to any of its kind.

10

**SINGLE-SIDED CONFIGURATION: 60 X 36 INCHES;**  
DRIFTWOOD LOGS WITH ROCK EMBER MEDIA  
AND BLACK PAINTED LINER

ONE OF TWO DAVINCI FIREPLACES AT THE PAINE FIELD AIRPORT PASSENGER TERMINAL IN MUKILTEO, WA.  
SAFE TOUCH GLASS™ AND NO SAFETY SCREEN WERE THE PRIMARY REASONS DAVINCI WAS CHOSEN FOR THIS PROJECT.

11



*Traditional,  
Transitional or  
Contemporary.  
A style solution is  
possible for every  
individual taste.*

**SINGLE-SIDED CONFIGURATION: 60 X 20 INCHES;  
PLATINUM CRUSHED GLASS MEDIA, DRIFTWOOD LOGS  
AND BLACK GLASS LINER  
PRIVATE RESIDENCE**

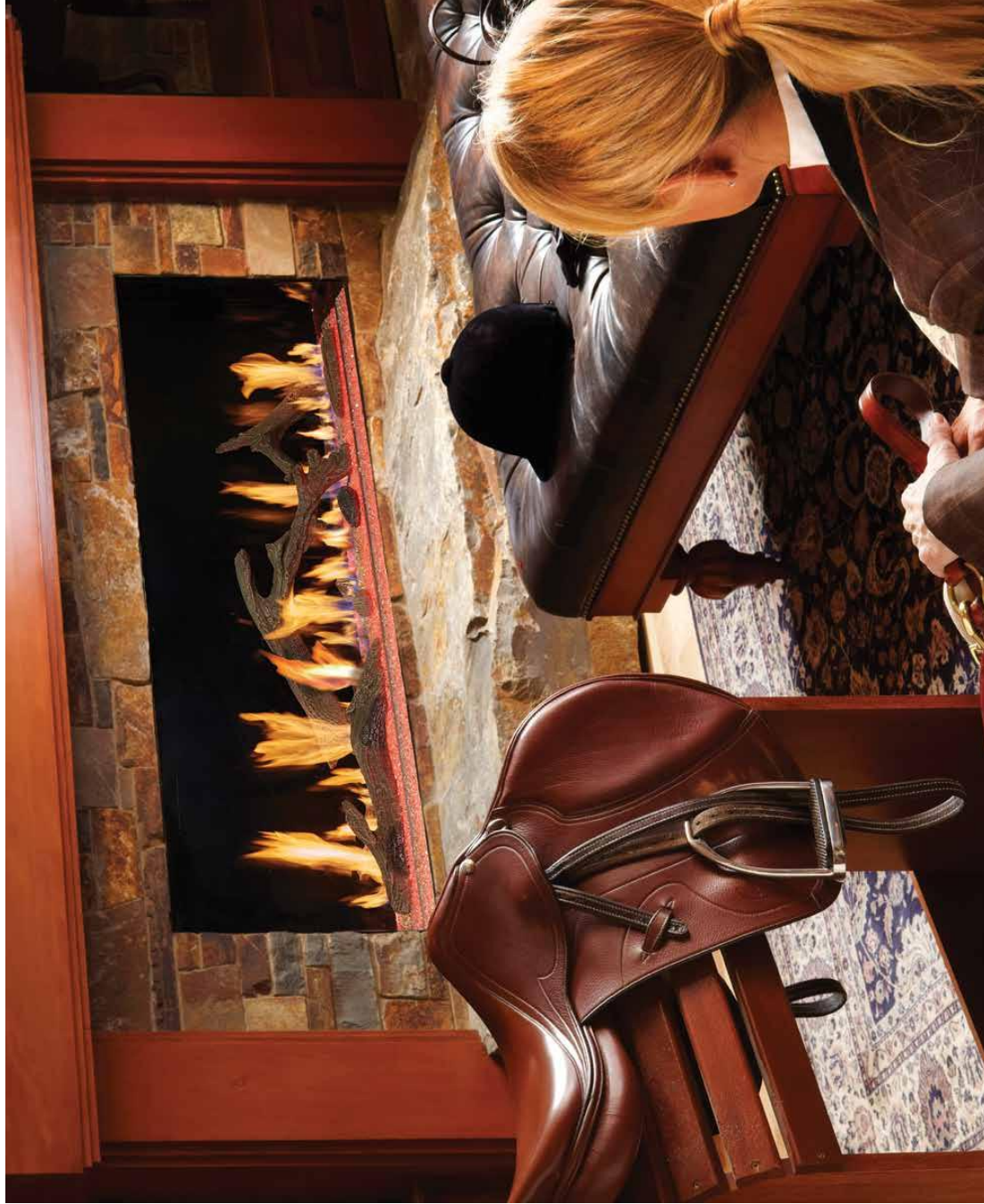





THE DAVINCI LINEAR COLLECTION

ISLAND CONFIGURATION: 72 X 20 INCHES;  
PLATINUM CRUSHED GLASS MEDIA  
PRIVATE RESIDENCE

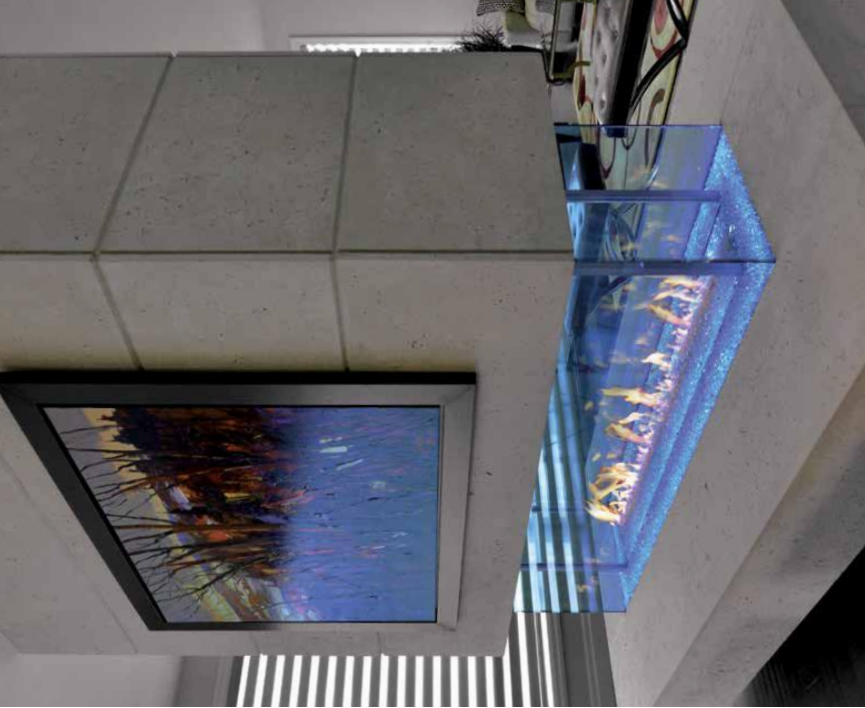

ISLAND CONFIGURATION: 72 X 20 INCHES;  
PLATINUM CRUSHED GLASS MEDIA  
PRIVATE RESIDENCE

### Island Configuration

Presented as a 360-degree wraparound view, the Island is a dramatic focal point in any contemporary, modern or transitional room.



## Left or Right Corner Configurations

A Corner DaVinci Fireplace adds visual depth and dimension to the fireview, while architecturally complementing a variety of applications.

16

WATCH THESE  
FIREPLACES  
BURNING



**LEFT AND RIGHT CORNER CONFIGURATIONS:**  
THIS LAS VEGAS HOME BRINGS TOGETHER TWO INDIVIDUAL DAVINCI CORNER INSTALLATIONS, DIVIDED BY A SLIDING GLASS WALL, TO FORM A MODERN INDOOR-OUTDOOR INTERPRETATION OF FIRE BEFITTING THE HOME'S LOCATION.  
A 102 X 20 INCH LEFT CORNER FIREPLACE IN THE MAIN LIVING AREA CREATES A VISUAL CONNECTION TO ANOTHER 90 X 20 INCH RIGHT CORNER FIREPLACE IN AN OUTDOOR COVERED PORCH.  
THE NEW AMERICAN HOME® 2018, LAS VEGAS, NV  
ARCHITECTS/BUILDERS: SUN WEST

17



THE DAVINCI LINEAR COLLECTION

**Bay Configuration**

Viewable from three sides, the Bay design is a window to a ribbon of beautiful flame, drawing the eye and captivating its audience.

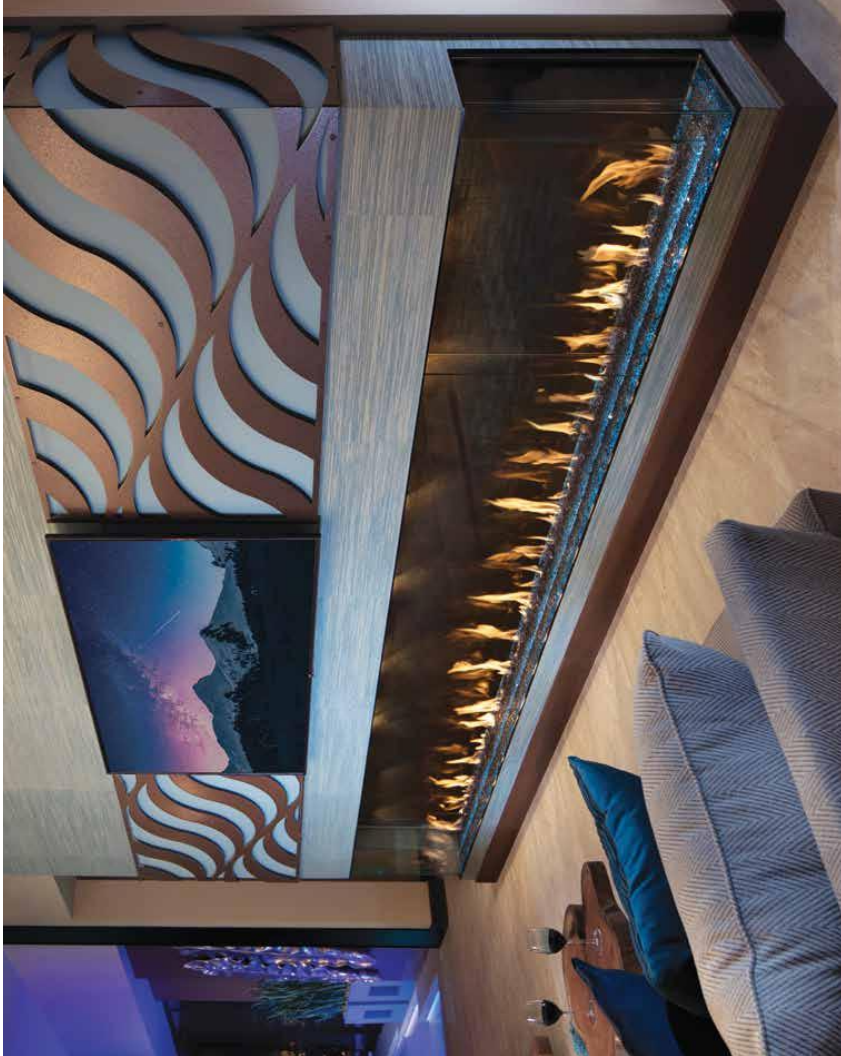

WATCH THIS  
FIREPLACE  
BURNING

**BAY CONFIGURATION: 209 X 30 INCHES;**  
BLACK GLASS MEDIA AND BLACK GLASS LINER  
THE NEW AMERICAN HOME® 2020, LAS VEGAS, NV

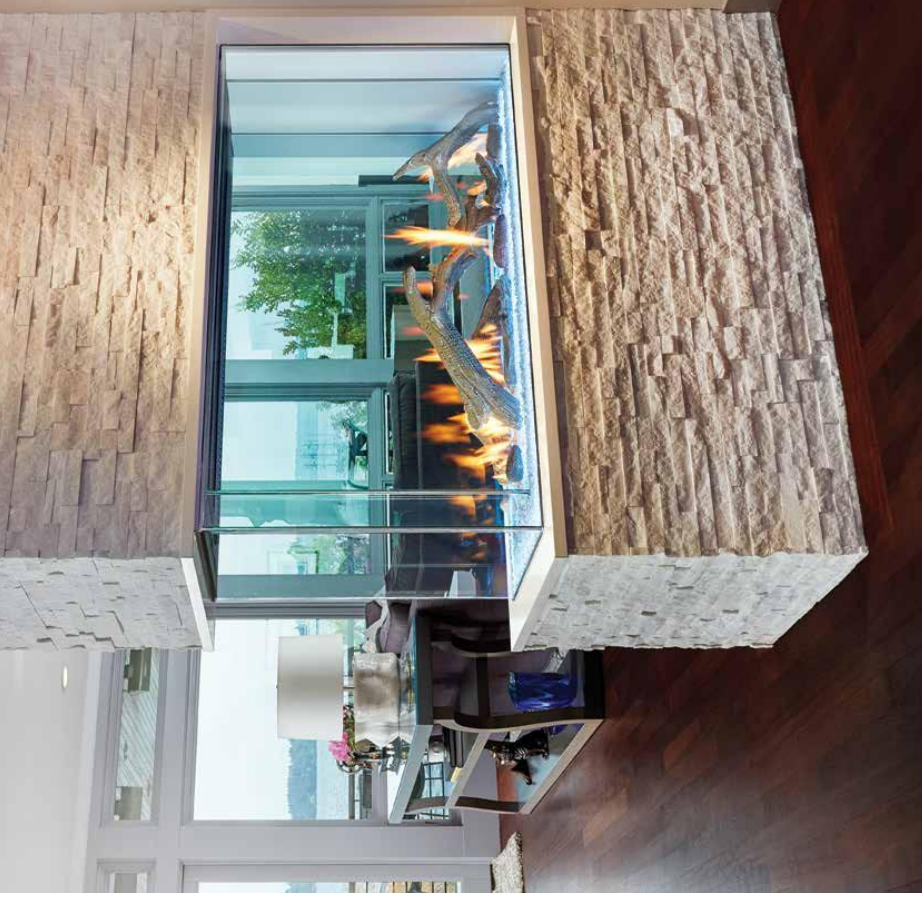

**PIER CONFIGURATION: 54 X 30 INCHES;**  
PLATINUM CRUSHED GLASS MEDIA,  
DRIFTWOOD LOGS AND SILVER PAINTED LINER  
PRIVATE RESIDENCE

**Pier Configuration**

Not only a mesmerizing complement to any space, the Pier serves as an alluring centerpiece that can divide large living spaces or join two smaller ones.



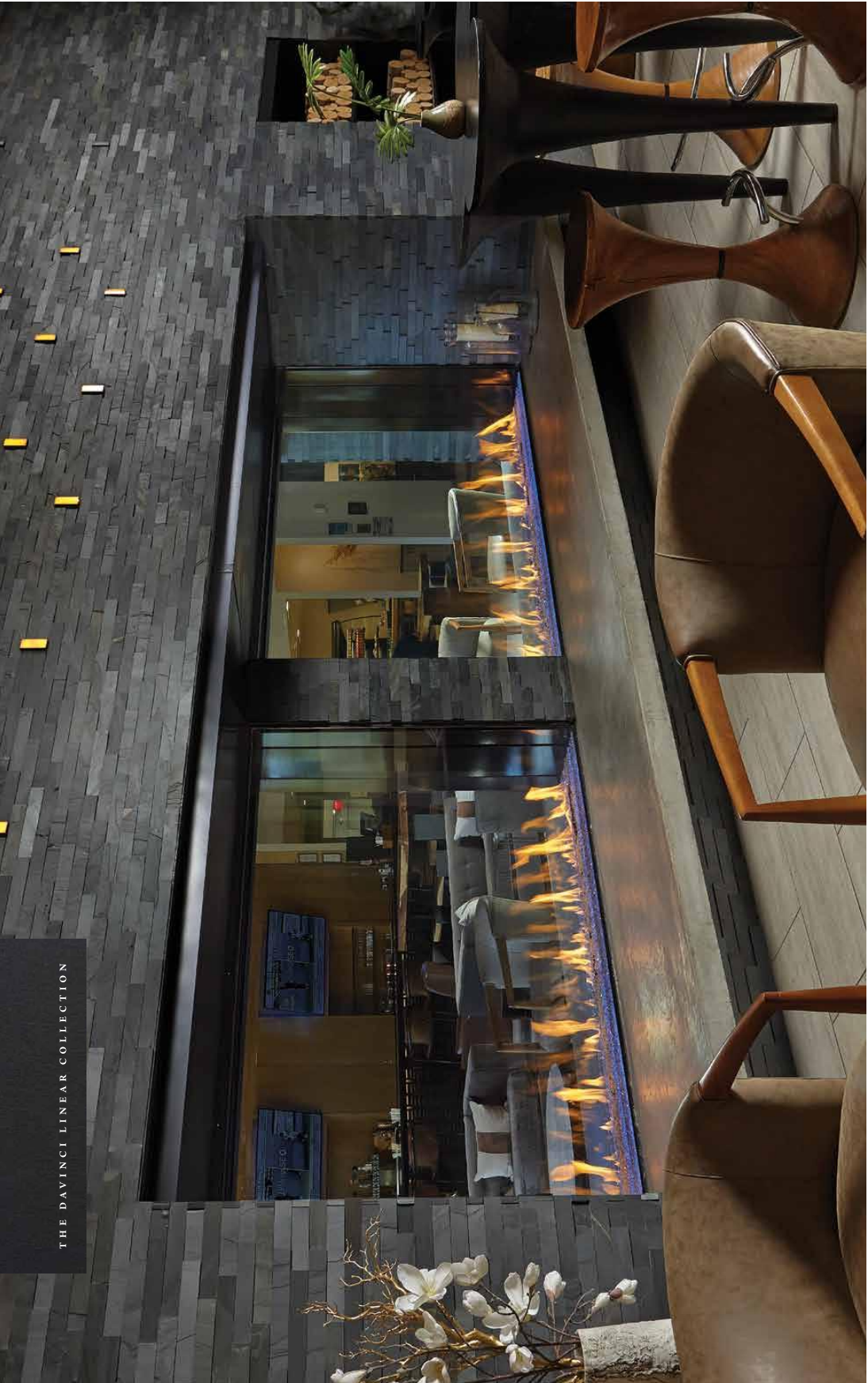

THE DAVINCI LINEAR COLLECTION

## See-Thru Configuration

A clear innovation in fireplaces that engages throughout. The See-Thru configuration opens up fresh possibilities for designers and architects.



WATCH THESE  
FIREPLACES  
BURNING

TWIN 96 X 56 INCH SEE-THRU FIREPLACES CREATE A DRAMATIC SPACE SEPARATION IN THIS HILTON DOUBLETREE, LOCATED IN VAIL, CO.



## See-Thru Configuration Featuring the Exterior Window Kit

Breathtakingly stylish, the See-Thru fireplace with the optional Exterior Window Kit provides the ability to create undreamed of dimensions of fire indoors, outdoors...or both.



SEE-THRU CONFIGURATION WITH EXTERIOR WINDOW KIT, 60 X 58 INCHES;  
OUTDOOR VIEW



SEE-THRU CONFIGURATION WITH EXTERIOR WINDOW KIT, 60 X 58 INCHES;  
BLACK CRUSHED GLASS MEDIA, DRIFTWOOD LOGS  
AND BLACK ENAMEL LINER  
YALE APARTMENTS, SEATTLE, WA

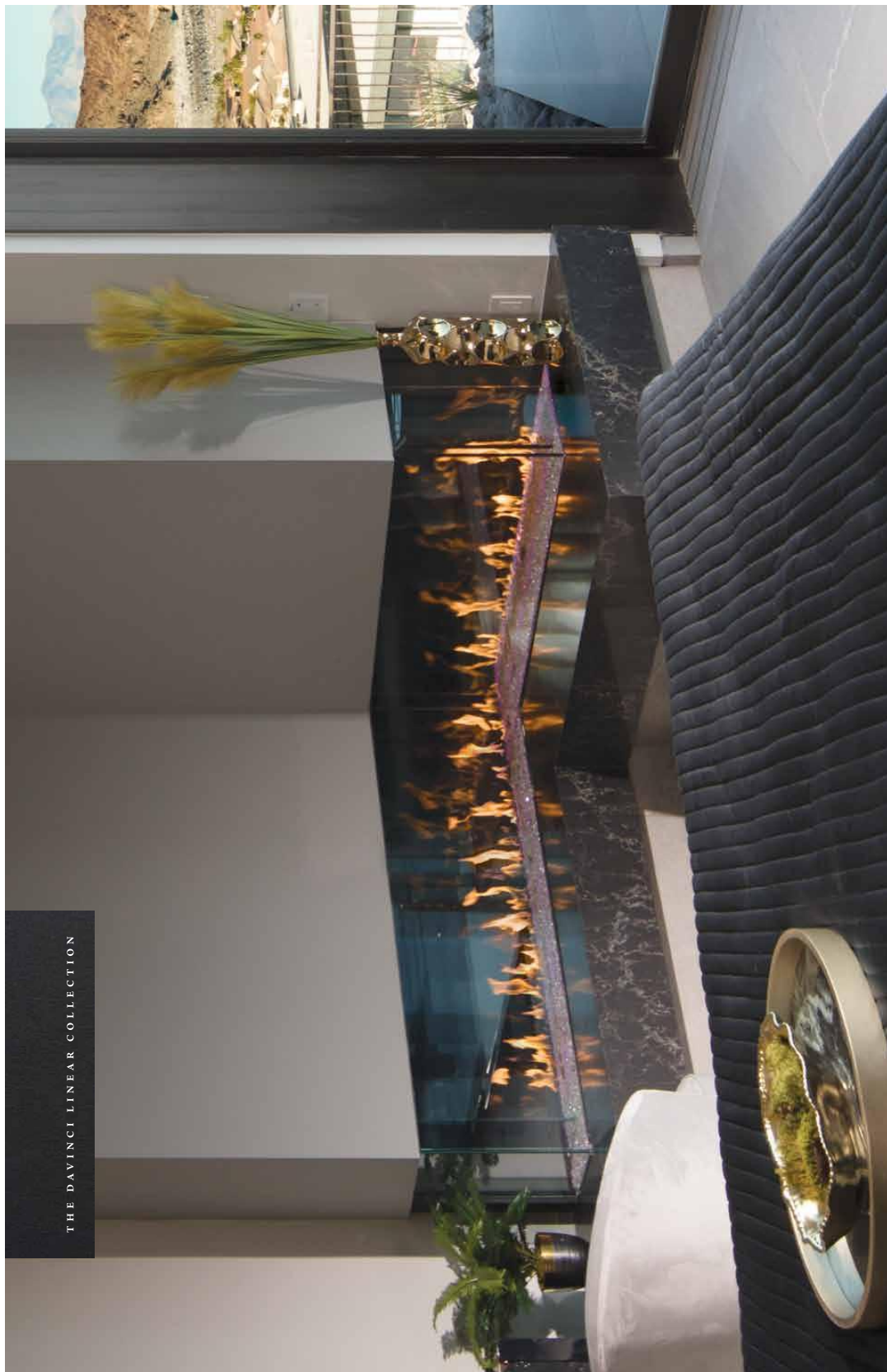

**"L" CONFIGURATION- 54 INCH LEFT CORNER X 54 INCH RIGHT CORNER X 20 INCH-  
PLATINUM CRUSHED GLASS MEDIA AND BLACK GLASS LINER**

## **"L" Configuration**

Stage a larger-than-life presentation with our "L" corner configuration. This impressive, 90-degree arrangement surprises and delights, and can incorporate single or multiple corners. This can be combined with any of the DaVinci Single-Sided, See-Thru, Corner, Bay, Island or Pier fireplaces, along with the Exterior Window Kit.

### *Any Combination You Can Dream Off*

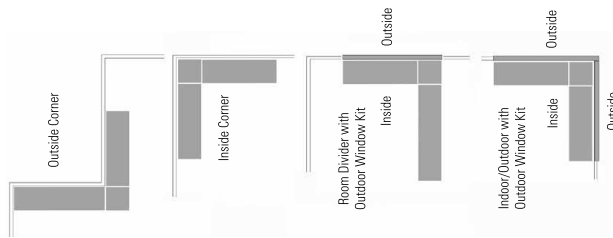

**THE NEW AMERICAN HOME® 2019, LAS VEGAS, NV  
ARCHITECTS/BUILDERS: SUN WEST**



# THE DAVINCI MAESTRO™ COLLECTION

*Captivating fireplaces unlike anything you've ever seen.*

The Maestro™ Collection features sixteen uniquely individual fireplaces in Square and Vertical configurations. Known for their signature Bon-Fyre™ flame and unexpected portraits, these fireplaces leave a lasting impression day after day.

-  FOUR STUNNING CONFIGURATIONS (SQUARE AND VERTICAL, AVAILABLE AS SINGLE-SIDED OR SEE-THRU)
-  FOUR DRAMATIC GLASS HEIGHTS
-  WIDTHS FROM 2 TO 4 FEET
-  SAFE TOUCH GLASS™ (NO SAFETY SCREENS OR NOISY FANS)
-  SIGNATURE VERTICAL BON-FYRE™ FLAME
-  AVAILABLE BON-FYRE™ LOGS
-  MULTICOLOR LED UNDERLIGHTING
-  OVERHEAD ACCENT LIGHTING
-  ANSI CERTIFIED NON-HEATER RATED DECORATIVE FIREPLACE



**SQUARE CONFIGURATION: 36 X 36 INCHES;**  
PLATINUM CRUSHED GLASS MEDIA  
AND BLACK GLASS LINER

2019 NAHB INTERNATIONAL BUILDERS' SHOW,  
KOHLER® BOOTH, LAS VEGAS, NV

THE DAVINCI MAESTRO™ COLLECTION



36" x 36"  
SQUARE

48" x 48"  
SQUARE

24" x 36"  
VERTICAL

36" x 48"  
VERTICAL

36" x 58"  
VERTICAL

Square  
Configuration

- 36 x 36 INCHES
- 48 x 48 INCHES

Vertical  
Configuration

- 24 x 30 INCHES
- 24 x 36 INCHES
- 24 x 48 INCHES
- 24 x 58 INCHES
- 36 x 48 INCHES
- 36 x 58 INCHES

All Maestro™ Square fireplaces are available as Single-Sided or See-Thru, with the option of adding the Exterior Window Kit.

All Maestro™ Vertical fireplaces are available as Single-Sided or See-Thru, with the option of adding the Exterior Window Kit.

## Square Single-Sided™ Maestro Configuration

Modern Maestro™ Collection  
Square gas fireplaces  
command the focus of  
any room.



SQUARE SINGLE-SIDED CONFIGURATION, 48 X 48 INCHES,  
PLATINUM CRUSHED GLASS MEDIA AND BON-FYRE™ LOG SET  
RESTAURANT BAR



## Vertical Single-Sided Maestro™ Configuration

The Maestro™ Collection Vertical gas fireplaces harness technological innovation with the magnificence of a tall flame. Available in several heights to fit the proportions of any room.

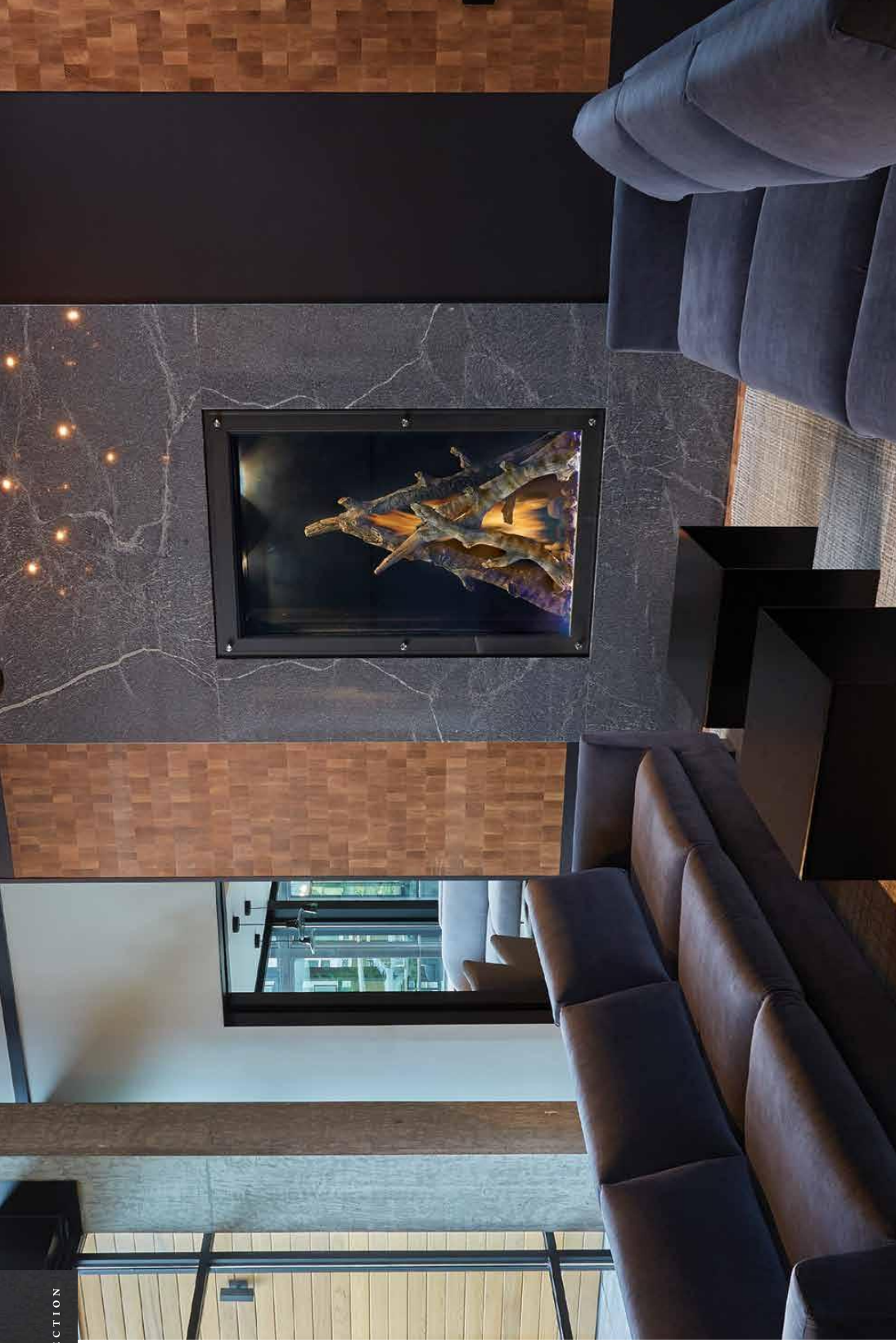

VERTICAL SINGLE-SIDED CONFIGURATION: 36 X 58 INCHES;  
PLATINUM CRUSHED GLASS MEDIA  
AND BON-FIRE™ LOG SET

HYDE PARK APARTMENTS, BELLEVUE, WA  
SAFE TOUCH GLASS™ WAS THE PRIMARY SELLING  
POINT FOR THIS CUSTOMER

THE DAVINCI MAESTRO™ COLLECTION

**Vertical See-Thru Maestro™ Configuration  
Featuring the Exterior Window Kit**

All Maestro™ fireplaces have the option of adding the Exterior Window Kit for the ultimate indoor-outdoor presentation of fire.

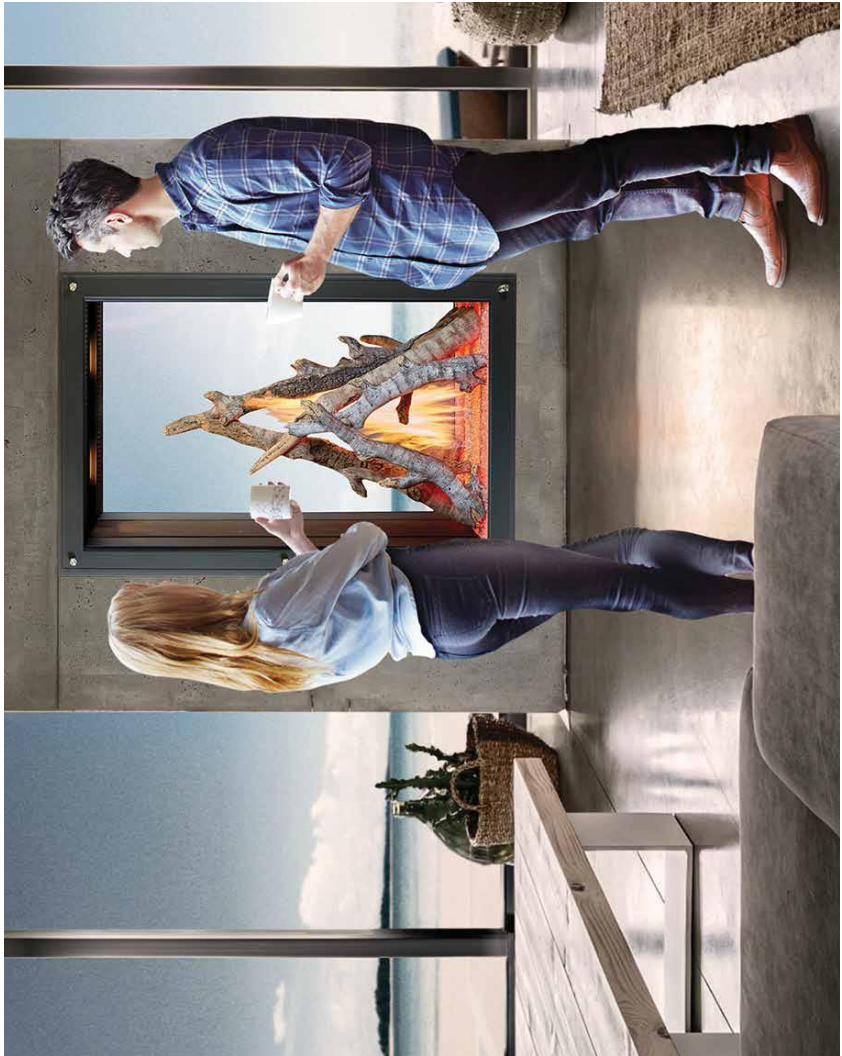

**VERTICAL SEE-THRU CONFIGURATION  
WITH EXTERIOR WINDOW KIT: 36 X 58 INCHES;  
PLATINUM CRUSHED GLASS MEDIA AND BON-FYRE™ LOG SET**

**I N N O V A T I O N S**  
—  
*A Spark of Brilliance*



## Certification & Modular Construction

U. S. and Foreign Patents Pending.

### Certification

All fireplaces are safety tested and listed prior to delivery. There are no additional certification costs. Listed to: ANSI Z21.50b-2014, CSA 2.22b-2014, and CSA P.4-1-15.

### The World's Only Modular Fireplace

DaVinci Custom Fireplaces™ have been installed as long as 66 feet in length, and because the design is modular, these fireplaces can be easily and efficiently transported and installed on the job site.

Combine 2, 3, 4 and 5 foot lengths to create your custom DaVinci with the revolutionary, patent pending Titan Lock System™ that allows these fireplaces to be bolted together without any additional framing, wall support or machinery. No special building entries are required for these modular fireplaces, as they fit through normal doorways, stairwells and elevators.

1. The Leveling Track can be delivered, set and leveled ahead of time.

2. The fireplace segments are set into the track and simply slide together.

3. These segments are then bolted together with the Titan Lock System™.

4. B-Vent chimney connects to the Power Vent Exhaust System

5. Outside air inlet ducts supply fresh air into the fireplace for cooling and combustion.

6. Glass panels are set into place.

7. Power and gas locations can be selected when ordering fireplace.

3.6

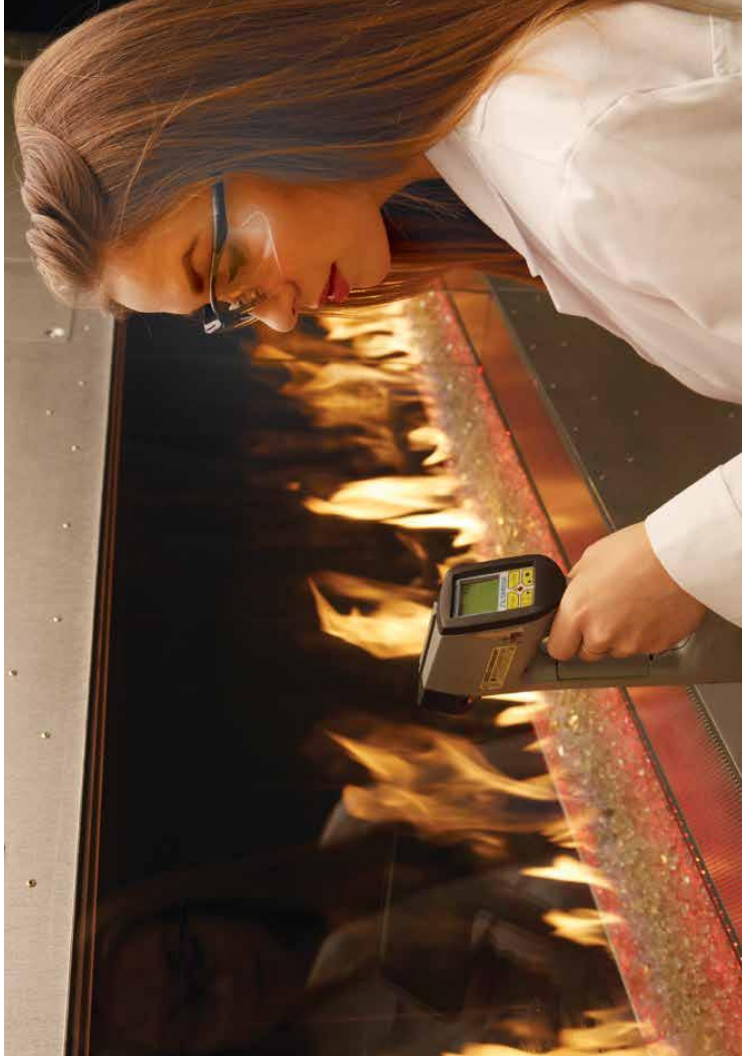

## Safe Touch Glass™ Is the Difference You Can Feel

Crystal-clear Safe Touch Glass™—a standard feature for all DaVinci Custom Fireplaces™—eliminates the need for a protective screen and reassures that the fireplace is safe for any public or private space.

3.7

DAVINCI CUSTOM FIREPLACES™  
INNOVATIONS

## An Inspired Spectrum of Color and Media Selections

Personalize your own perfect ambiance with full spectrum LED underlighting controlled via TouchSmart™. Davinci Custom Fireplaces™ also feature overhead halogen lighting to highlight the beauty of your fireplace even when it isn't lit.

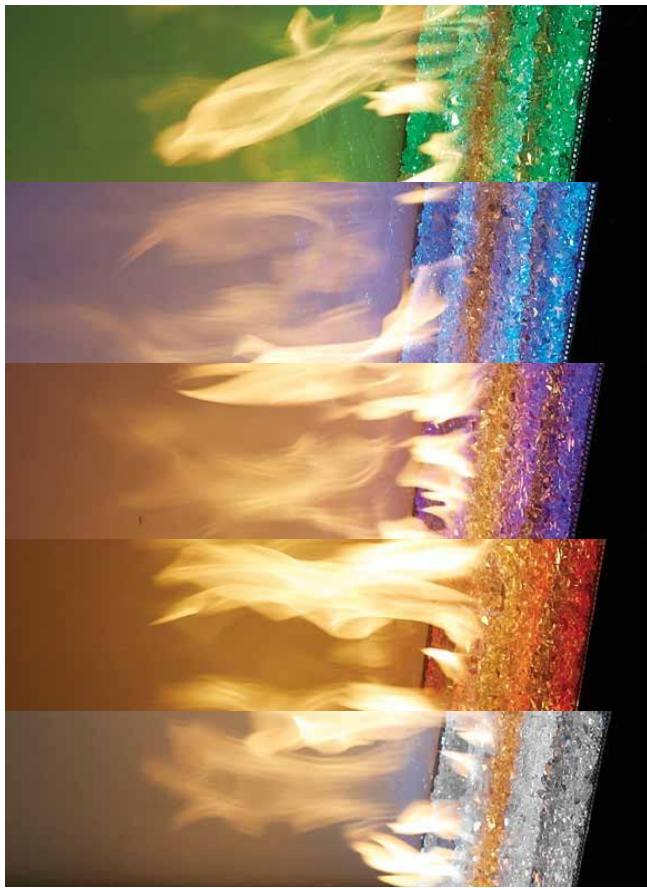

CHOICE OF THREE DIFFERENT MEDIA OPTIONS | PLATINUM CRUSHED GLASS SHOWING VARIATIONS OF COLORED LED LIGHTS

## Elegant TouchSmart™ Wall Controls



Davinci Custom Fireplaces™ feature our easy-to-use TouchSmart™ Wall Control interface. The sleek glass panel, in your choice of black or white finishes, connects you to technical features that DaVinci has perfected, including a controllable heat exchanger, a 10-hour timer and full spectrum under-lit LED lighting to help set the mood.

Hearth Industry Vesta™ Award Winner for Best Hearth Components & Controls.



BLACK CRUSHED GLASS | ROCK EMBERS



## Home Automation Interface

All DaVinci's are compatible with Home Automation.

- Lutron™
- Crestron™
- Savant™
- Leviton™
- Control4™



We offer a FREE Control4™ driver that can be downloaded at:

[www.chowmainsoft.com/davinci-control4](http://www.chowmainsoft.com/davinci-control4)



## Zero Clearance to Combustible Surfaces

The DaVinci Custom Fireplace™ remains cool by the way outside air is ducted in and around the unit, and between the two panes of glass. This eliminates the need for using expensive steel studs or non-combustible building materials and gives you the freedom to bring combustible finish materials right up to the edge of the frame-less glass. With all DaVinci Custom Fireplaces™ you have the ability to install a TV anywhere on the wall above the fireplace.



## Exterior Window Kit

DaVinci's extruded aluminum, thermal pane Exterior Window Kit allows you to feature any Linear or Maestro™ Single-Sided or See-Thru fireplace as an outdoor installation. The Exterior Window Kit can be added to one side of glass on a Single-Sided or See-Thru fireplace, or to both sides of glass on a See-Thru fireplace. This gives you the ability to feature an indoor-outdoor presentation of fire, or have a completely open outdoor fireplace, without requiring a roof or overhang.



DAVINCI CUSTOM FIREPLACES™  
INNOVATIONS

BON-FYRE™ LOGS AVAILABLE  
WITH THE MAESTRO™ COLLECTION

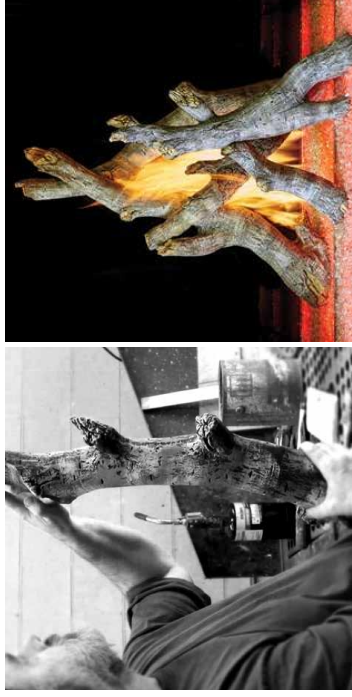

Select Your Choice of Fyre-Art™ for a  
More Personalized Presentation

Transform the overall look of your DaVinci Custom Fireplace™ with Fyre-Art™. Inspired by elements of nature, our in-house handcrafted Fyre-Art™ options include choices of logs, twigs, and stones to offer the most detailed and realistic media available anywhere.

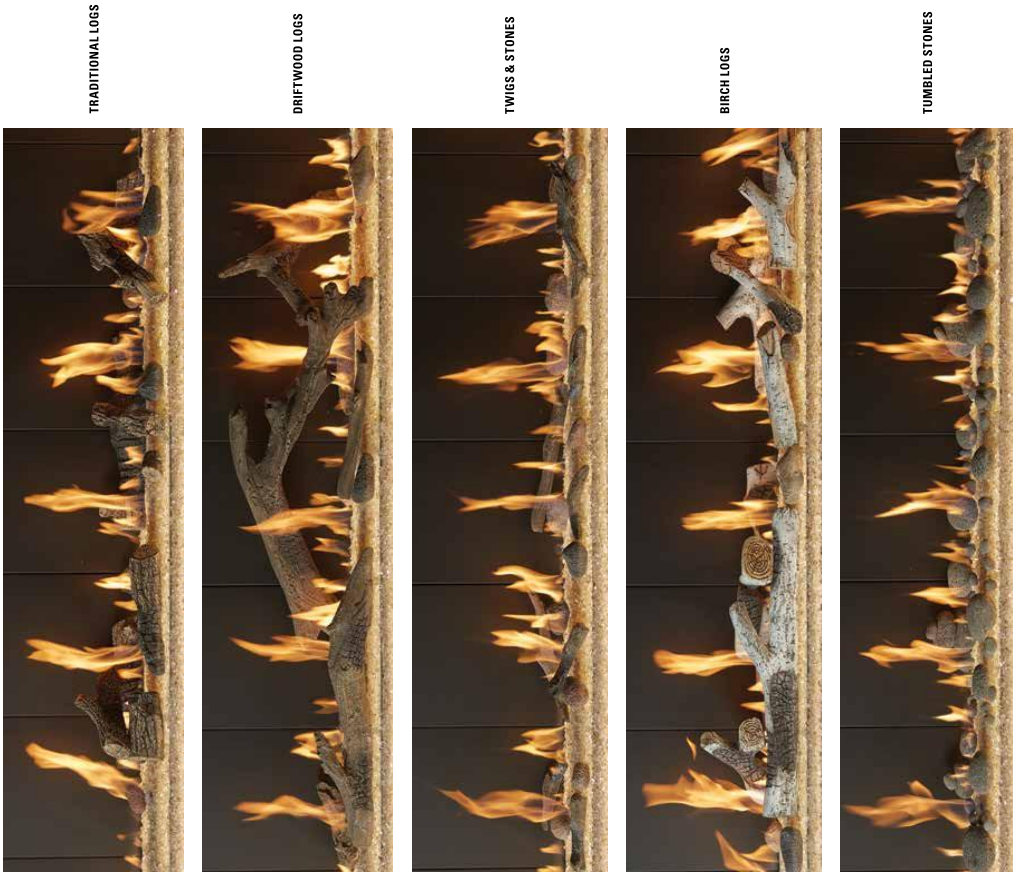



DAVINCI CUSTOM FIREPLACES™  
ARTISAN TRIMS



## Handmade Artisan Trims from Our Custom Shop

Impressive IronWorks™ trims are heavy-gauge steel individually hand-hammered by the blacksmiths at our in-house custom shop. These creations feature hammered, textured surfaces and intricate detailing, with finishes that are hand-applied and absorbed deep into the metal, imparting a rich luster and a timeless look.

Available in Bronze or Burnished Patina finishes.

2" Black Trim is also available to accent your DaVinci Fireplace.

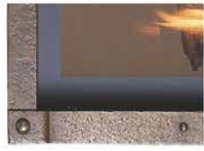

BRONZE PATINA  
IRONWORKS™  
PICTURED BELOW

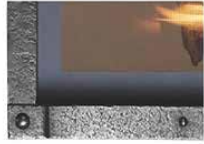

BURNISHED PATINA  
IRONWORKS™



2" BLACK PAINTED  
SMOOTH STEEL

## Choice of Liners

These contemporary liners provide a dramatic backdrop to the dancing flames of your DaVinci.



BLACK PAINT FINISH



SILVER PAINT FINISH



BLACK PORCELAIN ENAMEL



BLACK GLASS



## Post-less Design

All of our fireplace configurations, except the Island, feature a post-less design for the appearance of a clean, glass-to-glass edge and unobstructed viewing area.



## Heat Exchanger Kit

While DaVinci Custom Fireplaces™ are primarily designed as a non-heating appliance, there are occasions when some warmth is desired.

DaVinci Custom Fireplaces™ and Maestro™ models now offer a heat exchanger add-on option that allows you to vent warm air in the room where the fireplace is located.



## Venting - Vertical or Horizontal

All DaVinci Custom Fireplaces™ are power-vented. A quiet power vent system pulls combustion air into and around the fireplace while at the same time pushing combustion gases through the exhaust vent and out of the building. This system solves all venting challenges and accommodates extreme vent runs, including applications that terminate below the unit, allowing you to install a DaVinci anywhere you can imagine.

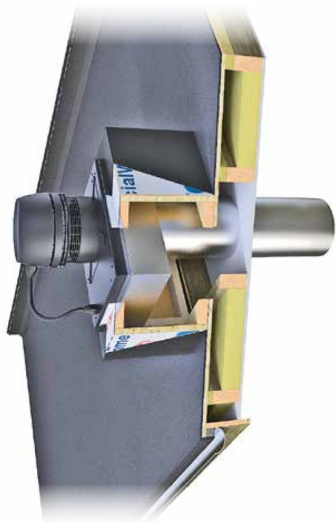

### Vertically Terminated Power Exhaust Fan

Check with your local building codes for snow pack height requirements.



### Horizontally Terminated Power Exhaust Fan

Fan motor is installed on the exterior of the structure. Allows easy access for service.

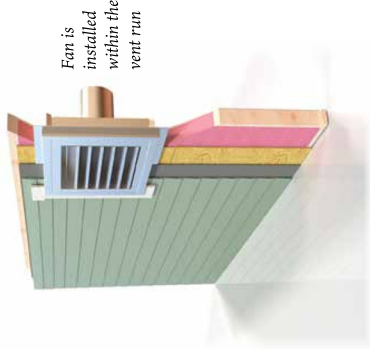

Fan is installed within the vent run

## Interior Power Exhaust Fan and Termination Cover

For a clean look on the outside of the structure, an Interior Power Exhaust Fan is built into the vent run and is available with our paintable termination cover.

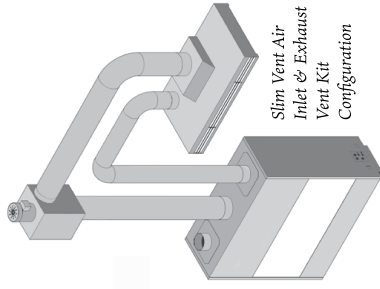

Slim Vent Air Inlet & Exhaust Vent Kit Configuration

## Slim Line Air Inlet & Exhaust Vent Kit Patent Pending

Designed for buildings with architectural restrictions on venting terminations, the Slim Line Air Inlet and Exhaust Kit allows you to vent the DaVinci Custom Fireplace™ in unobtrusive locations, such as above a window. Ask your DaVinci Specialist for details.

## Virtually Unlimited Vent Configurations

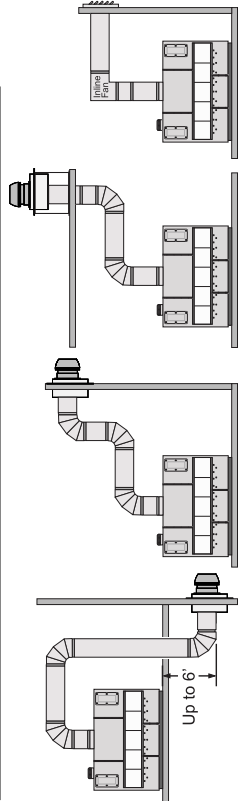

The Power Vent System on the DaVinci Custom Fireplace™ allows for nearly limitless venting configurations, even in the most challenging building situations.



**BUILT TO BE BETTER**  
*In Every Way*

Every DaVinci Custom Fireplace™ is thoughtfully designed to become the focal point of any room. Our products are created so that architects, designers and builders can install a custom gas fireplace almost anywhere.



**PIER CONFIGURATION: 60 X 20 INCHES:**  
DEGEN & DEGEN ARCHITECTURE AND INTERIOR DESIGN  
TOWNEPLACE SUITES SAN DIEGO AIRPORT  
PHOTO COURTESY OF INTERMOUNTAIN MANAGEMENT

**W E I N V I T E Y O U  
T O C O L L A B O R A T E W I T H  
U S O N Y O U R N E X T P R O J E C T**

**DaVinci advisors are available to you and your clients for consultations on planning, design or installation. We also invite you to review our numerous online resources at the links below.**

**Factory tours at our 11-acre House of Fire facility in Mukilteo, WA available by appointment.**

**Call 800.654.1177 or visit [DaVinciFireplace.com](http://DaVinciFireplace.com)**



**Scan the code above for technical documentation, CAD drawings and BIM objects available through ARCAT.**



**AIA accredited presentations available by appointment.**



**Follow us on Instagram & Facebook @DaVinciFire.**