



CAST IRON BAY WINDOW GAS STOVES

FEATURING GREENSMART™ TECHNOLOGY



NEVER BE COLD AGAIN!



NORTHFIELD™ SMALL BAY WINDOW CAST IRON GAS STOVE



Maximum BTU Input per Hour 22,000 (NG & LP)	Minimum BTU Input per Hour 6,700 (NG), 6,300 (LP)	Heating Capacity Up to 850 sq. ft.	Canadian P4.1 Efficiency 69.86% NG - 72.21% LP	Steady State Efficiency (High) Up to 79.96% (NG) Up to 81.37% (LP)	Weight 130 Lbs (59 Kg)
--	--	---------------------------------------	---	--	---------------------------



NORTHFIELD™

(SMALL BAY WINDOW CAST IRON STOVE)

The Northfield™ cast iron gas stove is a true work of art. It's classical Early American design and three-side bay window fireview more resembles a piece of fine furniture than a gas stove. And despite its size, the Northfield™ boasts an incredibly large 283 square inches of ceramic glass – which highlights the realistic wood-like fire from any angle in the room.

FEATURES YOU'RE GOING TO LOVE

- Award winning Ember-Fyre® Burner features realistic logs, glowing embers and the most wood-like fire of any gas stove.
- Standard GreenSmart™ Remote system with automatic heat/flame adjustment with a huge high-to-low flame turndown ratio - up to 70%.
- Comfort Control™ that allows you to turn off the rear burner for less heat to provide for year-round enjoyment of the fire.
- Built-in battery backup allows continued operation of your gas stove during power outages. Automatically switches back to AC when the power comes back on.
- Choice of pilot ignition modes - Choose GreenSmart™ Pilot setting to save money or Continuous Pilot during winter months where a heated chimney is needed to maintain the draft to ensure proper operation.
- The 130 CFM fan increases efficiency by enhancing the transfer of convective heat in your home. The standard fan heats your home more quickly than natural convection alone.
- The accent light adds a glowing back-light behind the logs and against the beautiful standard cast iron fireback, making your Northfield™ a focal point of the room. This adjustable light is perfect as a night light or as a soft indirect light for the room.

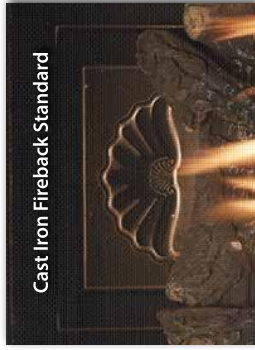

Cast Iron Fireback Standard



BERKSHIRE™
MEDIUM BAY WINDOW CAST IRON GAS STOVE



Maximum BTU Input per Hour 31,000 (NG & LP)	Minimum BTU Input per Hour 10,700 (NG) 12,600 (LP)	Heating Capacity Up to 1,500 sq. ft.	Canadian PA.1 Efficiency 70.82% NG - 71.56% LP	Steady State Efficiency (High) Up to 78.13% (NG) Up to 79.96% (LP)	Weight 215 Lbs (97 Kg)
--	---	---	---	--	---------------------------

BERKSHIRE™
(MEDIUM BAY WINDOW CAST IRON STOVE)

Think of the Berkshire™ as a functional work of art. Its classic balance, three-side bay window fireview and symmetry resembles a piece of fine furniture. This solidly built stove features decorative cast iron on the outside with a heavy-gauge unibody steel firebox for added durability on the inside. Design details include a large glass area, and delicate cast iron moldings that are typical of early American architectural style.

FEATURES YOU'RE GOING TO LOVE

- Award winning Ember-Fyre® Burner features realistic logs, glowing red embers and the most wood-like fire of any gas stove.
- Standard GreenSmart™ Remote system with Easy Heat/Flame Adjustment with a huge high-to-low flame turndown ratio - up to 70%.
- Comfort Control™ that allows you to turn off the rear burner for less heat and provides year-round enjoyment of the fire.
- 130 CFM Convection Blower will enhance the transfer of the natural radiant and convective heat.
- Built-in battery backup allows continued operation of your gas stove during power outages. Automatically switches back to AC when the power comes back on.
- Choice of pilot ignition modes - Choose GreenSmart™ Pilot setting to save money or Continuous Pilot during winter months where a heated chimney is needed to maintain the draft to ensure proper operation.
- The Accent Light adds a glowing light up the interior of the firebox and can be used even when the fire is off.



GREENFIELD™

LARGE BAY WINDOW CAST IRON GAS STOVE



GREENFIELD™

(LARGE BAY WINDOW CAST IRON STOVE)

The Greenfield™ cast iron gas stove is a true revolution in stove design. Combining clean lines, graceful proportions and traditional cast appeal, this wide, bay window stove can be considered a freestanding fireplace! The number one feature on the Greenfield™ is the incredibly large 522 square inches of ceramic glass. The open, three-side glass design allows you to view the incredibly realistic log set and dancing-flames from any angle in the room.

FEATURES YOU'RE GOING TO LOVE

- Award winning Ember-Fyre® Burner features realistic logs, glowing red embers and the most wood-like fire of any gas stove.
- Standard GreenSmart™ Remote system with Easy Heat/Flame Adjustment with a huge high-to-low flame turnaround ratio - up to 70% NG and 82% LP.
- Comfort Control™ that allows you to turn off the rear burner for less heat and provides year-round enjoyment of the fire.
- Built-in battery backup allows continued operation of your gas stove during power outages. Automatically switches back to AC when the power comes back on.
- Choice of pilot ignition modes - Choose GreenSmart™ Pilot setting to save money or Continuous Pilot for colder climates where a heated chimney is needed to maintain the draft to ensure proper operation.
- 160 CFM Convection Blower enhances the transfer of the natural radiant and convective heat from the stove into your home.
- The standard Accent Light adds a glowing light above the logs and against the beautiful optional fireback whether your fire is on or off. This adjustable light is perfect as a night light or as a soft indirect light for the room.



Maximum BTU Input per Hour 40,000 (NG & LP)	Minimum BTU Input per Hour 11,900 (NG) 7,400 (LP)	Heating Capacity Up to 2,000 sq. ft. with fan	Canadian P4.1 Efficiency 70.55% NG - 71.93% LP	Steady State Efficiency (High) Up to 79.3% (NG) Up to 80.37% (LP)	Weight 310 Lbs (140 Kg)
--	--	--	---	---	----------------------------



CAST IRON GAS STOVES FEATURING 3-SIDE BAY WINDOW FIREVIEWING

BUILDING NORTH AMERICA'S FAVORITE FIRE

Lopi heating appliances are designed and hand-assembled at our state-of-the-art plant in Mukilteo, Washington. With over 38 years of experience manufacturing innovative hearth products, Lopi has gained a reputation for standing behind every single product we make. Some things that haven't changed throughout the years are the quality of the construction, the beauty of our gas stoves, performance you can trust, and our commitment to your satisfaction.

WHY BUY A LOPI GAS STOVE?

Like all Lopi gas products, our gas stoves are serious heaters. They are all listed as heater rated furnaces. Lopi gas stoves provide radiant heat to the immediate area, and unlike most cast iron stoves they have the added benefit of a built-in convection chamber, which circulates room air around the appliance and returns it to your room as heat. All stoves come equipped to burn natural gas (NG) or can easily be converted to propane (LP).

THREE DISTINCT CAST IRON MODELS TO CHOOSE FROM:



NORTHFIELD™
22,000 BTU
(SMALL)



BERKSHIRE™
31,000 BTU
(MEDIUM)



GREENFIELD™
40,000 BTU
(LARGE)

REVOLUTIONARY GREENSMART™ SYSTEM

All models feature the revolutionary GreenSmart™ gas burner system and realistic Ember-Fyre® burner. The GreenSmart™ system is the latest in energy-efficient gas technology that heats the home while saving on energy usage and lowering heating bills. The real power of the GreenSmart™ system is the entire collection of components, controls and technology features. Please refer to page 10 for more detailed information.

INCREDIBLE EMBER-FYRE® TECHNOLOGY

You'll be amazed at the realism of our gas fire thanks to our patented Ember-Fyre® burner technology. Dancing yellow flames and glowing embers capture all the beauty of a real wood fire. It's the most realistic gas fire available - so real, that Popular Science® magazine awarded the Ember-Fyre® one of its top 100 innovations of the Year! You might even be tempted to stir the embers and add more wood.



CAST IRON GAS STOVES FEATURES

NEW IRON STOVE FINISH

A soft charcoal paint that echoes the richness of cast iron and helps to highlight the beautiful cast details.



FLEXIBLE INSTALLATION

Lopi gas stoves feature direct vent technology and can be vented vertically or horizontally (top vent with the Berkshire and top or rear (top vent on the Northfield™ and Greenfield™) or up an existing chimney when installed as a hearth stove. This allows for location flexibility, and in many cases lowering installation cost.

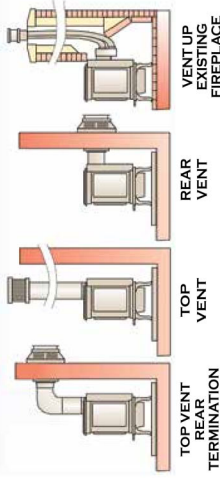

Rear Vent Installation - The Northfield™ and Greenfield™ gas stoves have a rear vent installation option to make installing your unit as quick and easy as possible. The Minimum Rear Vent Kit is designed to give your stove optimum performance. Included in the Minimum Rear Vent Kit are: Flue adapter, 3.9" section, wall thimble, wall thimble cover, and a horizontal cap. This comes with everything you need to install your gas stove in the most cost-effective way. Talk to your Lopi™ dealer about this option.



Top or Rear Vent Choice

7-YEAR "REAL WORLD" WARRANTY

Our 7-Year Warranty offers more protection on key components than the so-called "limited lifetime" warranties of our competitors. Lopi builds stoves to last a lifetime.

We'll stand behind the quality and performance of our products year after year because that's the way we do business - and you don't have to read the fine print for your peace of mind.



YEARS 1-2:
All parts and labor on your gas burning appliance, including blower and one-way freight allowance.

YEARS 1-7:
All parts and labor on the firebox and one-way freight allowance.



GREEN SMART™ FEATURES

GREENSMART™ TECHNOLOGY

All 3 models feature the latest, most efficient gas technology with enhanced conveniences available and include standard convection fans and GreenSmart™ remote control.

MULTI-FUNCTION WIRELESS THERMOSTAT REMOTE CONTROL

- Thermostat
- Fan Operation
- Comfort Control™
- Flame Adjustment
- Accent Light Control
- GreenSmart™/CPI Pilots



CONTINUOUS PILOT OR GREENSMART™ PILOT:

This switch or your GreenSmart™ remote allows you to run your stove in either Continuous Pilot mode or GreenSmart™ mode. In Continuous Pilot mode, the pilot flame stays on and is ideal during cooler temperatures when maintaining a warm flue ensures reliable operation, keeps chimney caps free of ice and snow, and reduces condensation on the glass. In GreenSmart™ mode, the pilot flame ignites via an intermittent (IPI) spark. It does not run continuously and thus conserves energy when the appliance is not being operated. The GreenSmart™ system includes an automatic battery back-up, ensuring proper ignition even during power outages.



Front Burner Only



Front and Rear Burners On

CONTROL SETTINGS

FLAME ADJUSTMENT

Control the height/heat of the flame as you desire. 6 levels of flame height to choose from. Not used while in Smart Thermostat setting.



CONVECTION FANS

Fans circulates room air around the firebox and delivers heated air into your home. 6 speeds to choose from.



ACCENT LIGHTS

Create a warm glow to highlight the fireplace interior. Use year-round to add ambiance. 6 levels to choose from.



COMFORT CONTROL™

Turns off the back burner lowering the BTU input. Allows you to burn less gas on milder days when you want to enjoy a fire and not overheat your living area.



HEAT SETTINGS



MANUAL ON/OFF

Fire stays where you manually set it.

THERMOSTAT

Turns fire ON or OFF to maintain your desired home/room temperature.

SMART THERMOSTAT

Fire height will adjust automatically (up or down or OFF) to better maintain your temperature setting while enjoying the flame more often. A greener way to heat.



Use mobile device to watch a video of how this GreenSmart™ remote works.

STOVE DIMENSIONS

NORTHFIELD™

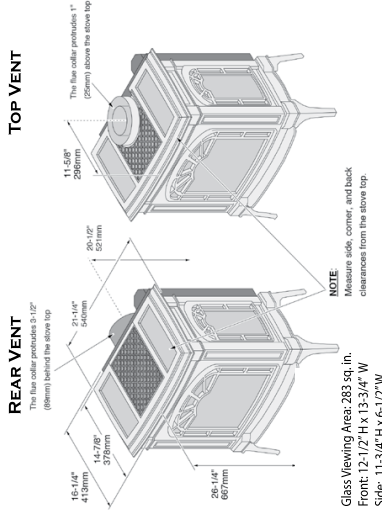

BERKSHIRE™ TOP VENT ONLY

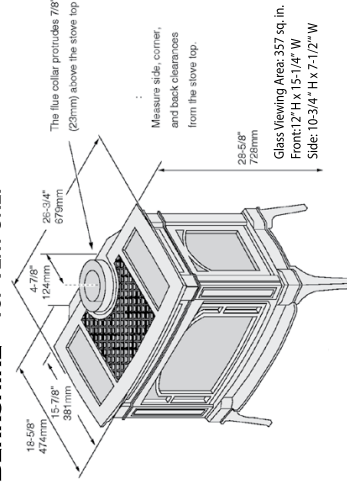

GREENFIELD™

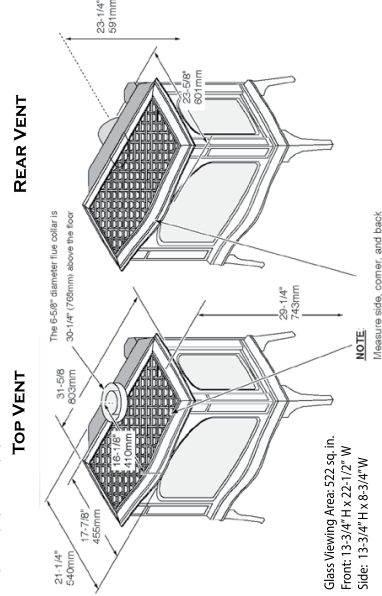

KEEP THEM WARM, KEEP THEM SAFE



To ensure maximum safety and enjoyment of your Lopi cast iron gas stove, we feature the ANSI approved invisible glass safety screen to prevent accidental contact with hot glass surfaces. This screen comes standard with each stove and is installed over all without detracting from the beautiful fire view.

Listing and IAS (ICBO) Approval

These appliances are listed to ANSI Z21.88 CSA 2.23, and approved to the Massachusetts Board of State Examiners of Plumbers and Gas Fitters. All units are mobile home approved to ANSI/NFPA 70 or CSA C22.1.

Heating Capacity

Heating capacity may vary depending on degree of home insulation, floor plan, ceiling height and the ambient temperature zone in which you live. Contact local building or fire officials about restrictions and installation requirements in your area. Your performance results may vary depending on vent configuration.

Gas Stove Efficiency

P4 Efficiency is a measure of a stove's energy efficiency performance over an entire heating season and is expressed as a percentage. The higher the rating, the more efficient the unit. Steady State Efficiency results may vary depending on the vent configuration.

STOVE PLACEMENT & CLEARANCES TO COMBUSTIBLES

LOCATION OPTIONS WITH DIRECT VENT SYSTEM

Direct Venting System provides for horizontal or vertical venting through the outside wall or ceiling, allowing you to install your stove virtually anywhere in the room. *Note: The Berkshire does not have an optional rear vent

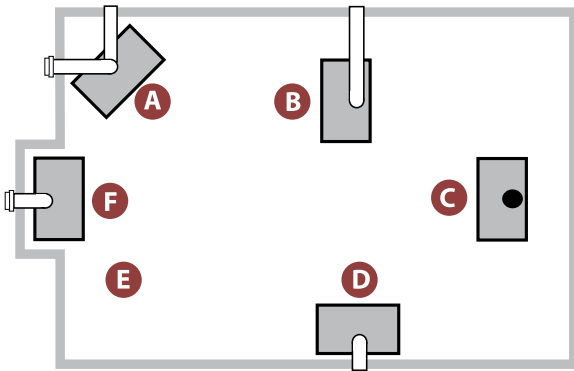

You can install your stove in any of these configurations:

- A - Cross Corner
- B - Room Divider
- C - Island
- D - Flat on Wall
- E - Flat on Wall Corner
- F - Flat with Wall/Alcove

Where would you like the stove to go in your home?

CLEARANCES TO COMBUSTIBLES

The information on this page is for reference ONLY! Installation information is available through your Lopi dealer or through the Lopi website at www.lopistoves.com.

All measurements are to be taken from stove top to combustible walls.

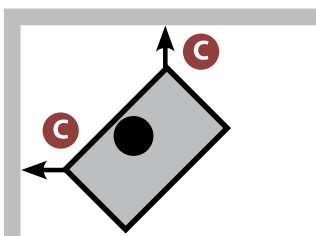
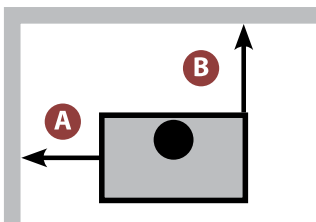

NORTHFIELD™ (SMALL)

A - Stove to Sidewall 3 1/2"
B- Stove to Backwall 5" (Top Vent) 8 1/2" (Rear Vent)

BERKSHIRE (MEDIUM)

A - Stove to Sidewall 10"
B- Stove to Backwall 5"

GREENFIELD (LARGE)

A - Stove to Sidewall 10"
B- Stove to Backwall 5" (Top Vent) 8 1/4" (Rear Vent)

NORTHFIELD™

C - Stove to Corner 1"

BERKSHIRE

C - Stove to Corner 5"

GREENFIELD

C - Stove to Corner 5"

HEARTH PADS

A non-combustible hearth pad is required when the stove is installed directly on carpeting, vinyl or combustible flooring other than wood. A metal or wood hearth pad must extend the full width and depth of the stove. No hearth pad is required if the stove is installed on non-combustible flooring (tile, stone, brick) or if installed on a wood or wood laminate floor.

Your Authorized Lopi Dealer Is Located At:



www.lopistoves.com

